

GVR Series

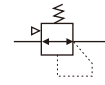

Ordering code

GVR 300 10 □ □ T

① ② ③ ④ ⑤ ⑥

① Model	② Series code	③ Port size	④ Accessories	⑤ Pressure gauge	⑥ Thread type
GVR: GVR series vacuum regulator	200: 200 series	06: 1/8" 08: 1/4"	Blank: Bracket J: No bracket	Blank: Pressure gauge N: No pressure gauge	T: NPT (kPa / psi)
	300: 300 series	08: 1/4" 10: 3/8"			

Specification

Model	GVR20006	GVR20008	GVR30008	GVR30010
Fluid	Air			
Port size [Note1]	1/8"	1/4"	1/4"	3/8"
Pressure range	-100~-1.3kPa			
Max. pressure	-1.0kPa			
Air inhalation consumption	0.6 L/min(ANR) and below			
Temperature range	-20~70°C			
Weight g	204	198	342	336

[Note1] NPT thread is available.

Product feature

1. The pressed-in self-locking mechanism can prevent the abnormal movement of the set pressure caused by external interfere.
2. The pressure regulation is stable, the drift is small and the pressure characteristic is good.
3. In addition to panel installation, the bracket is optional for installation.

Pressure chart

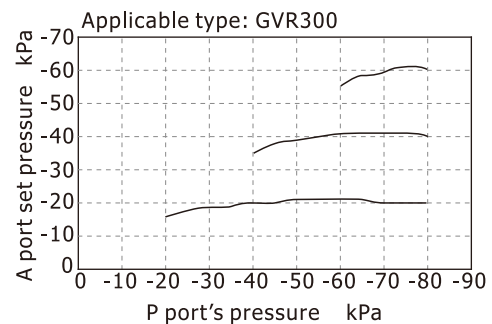
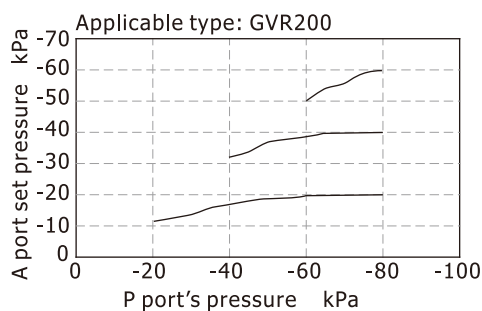

GVR Series

Installation and Application

1. Please be used with safety circuit to avoid accidents when power failure, vacuum pump and vacuum regulator fail.
2. When checking, please set the pressure to 0 (atmospheric pressure) and completely cut off the pressure of the vacuum pump before pulling down the tube of the regulator.
3. The vacuum regulator can not be used to regulate the pressure of the vacuum pump, if the flow capacity of the vacuum generator is less than the flow capacity of the vacuum regulator, it is not suitable as a vacuum source.
4. The regulating knob rotates clockwise, the atmospheric pressure changes to the vacuum pressure, turns counterclockwise, the vacuum pressure changes to atmospheric pressure.
5. After setting the pressure, press the button on the pressure adjusting button until you hear the click.
6. The vacuum regulator is used for negative pressure, and no positive pressure should be applied.

Inner structure

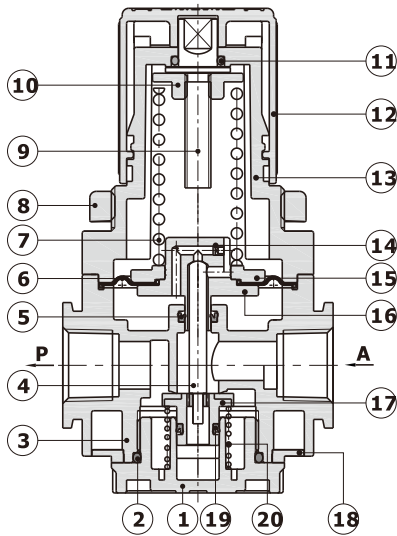

No.	Item
1	Valve cap
2	O-ring
3	Body
4	Spool
5	O-ring
6	Diaphragm
7	Spring
8	Fixed ring
9	Adjusting spindle
10	Regulator nut
11	O-ring
12	Pressure knob
13	Adjusting seat
14	Gas resistance
15	Diaphragm up core
16	Diaphragm down core
17	Pressure plug
18	Bottom cover
19	O-ring
20	Spring

Flow chart

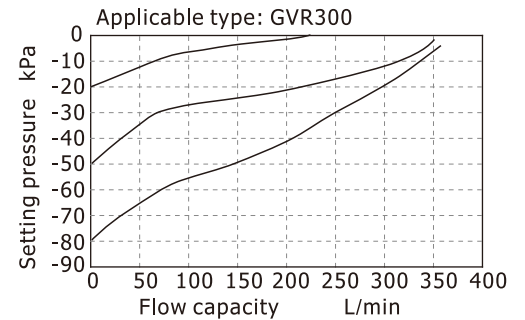
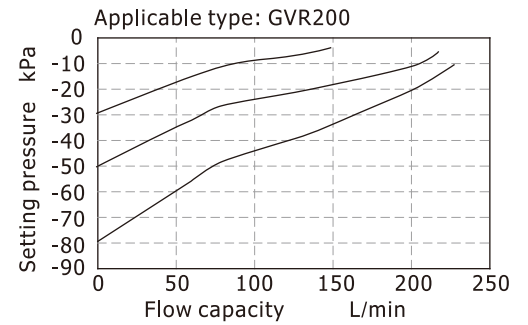

Dimensions

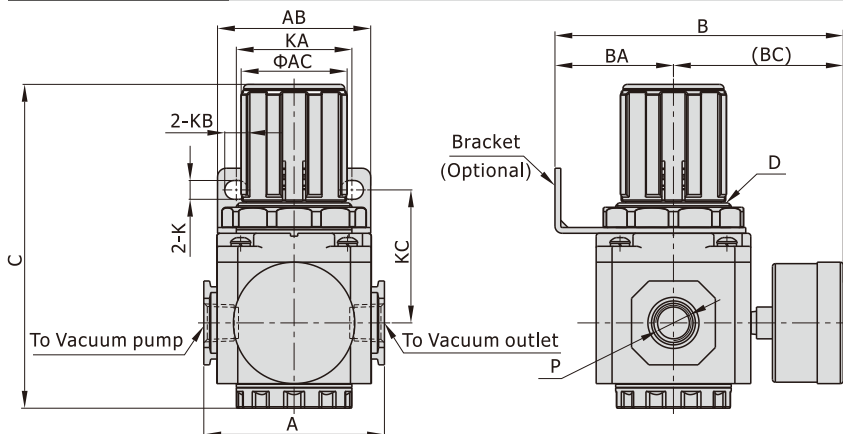

[Unit: mm]

Model \ Item	A	AB	AC	B	BA	BC	C
GVR20006	52.5	55	31	83	30	53	89
GVR20008	52.5	55	31	83	30	53	89
GVR30008	62.5	53	38	99.5	41	58.5	112
GVR30010	62.5	53	38	99.5	41	58.5	112

Model \ Item	D	K	KA	KB	KC	P
GVR20006	M33X1.5	5.4	34	15.4	43	1/8"
GVR20008	M33X1.5	5.4	34	15.4	43	1/4"
GVR30008	M40X1.5	6.5	40	8	46	1/4"
GVR30010	M40X1.5	6.5	40	8	46	3/8"