



Mini cylinder(Aluminum barrel)——MBL Series

Compendium of MBL Series

Multi-mounting accessories

LB Type

FA Type

SDB Type

Multi-type cylinder

MBL: Mini cylinder(Double acting)

MBLC: Mini cylinder(Double acting with cushion)

MSBL: Mini cylinder(Single acting_push)

MTBL: Mini cylinder(Single acting_pull)

MBLD: Mini cylinder(Double rod)

MBLCD: Mini cylinder(Double rod with cushion)

MBLJ: Mini cylinder(Adjustable stroke)

MBLCJ: Mini cylinder(Adjustable stroke with cushion)

Rolling packed structure

Front and back cover and stainless steel block adopt riveted rolling packed structure to form a reliable connection.

Six bore size are available

Bore size: 20, 25, 32, 40, 50, 63

Two kinds of back cover type

U: Flat-end type

CA: Pivot type

Multi-kinds of stroke

Two kinds of cushion type

Variable cushion or Bumper

Criteria for selection: Cylinder thrust

Unit: Newton(N)

Bore size	Rod size	Acting type	Pressure area(mm ²)	Operating pressure(MPa)							
				0.1	0.2	0.3	0.4	0.5	0.6	0.7	
20	8	Single acting	Push side	314.0	-	15.7	47.1	78.5	109.9	141.3	172.7
			Pull side	263.8	-	5.7	32.0	58.4	84.8	111.2	137.5
		Double acting	Push side	314.0	31.4	62.8	94.2	125.6	157.0	188.4	219.8
			Pull side	263.8	26.4	52.8	79.1	105.5	131.9	158.3	184.7
25	10	Single acting	Push side	490.6	-	24.6	73.7	122.8	171.8	220.9	269.9
			Pull side	412.1	-	8.9	50.1	91.4	132.6	173.8	215.0
		Double acting	Push side	490.6	49.1	98.1	147.2	196.2	245.3	294.4	343.4
			Pull side	412.1	41.2	82.4	123.6	164.8	206.1	247.3	288.5
32	12	Single acting	Push side	804.3	-	40.2	120.6	200.9	281.3	361.7	442.1
			Pull side	691.2	-	17.6	86.6	155.7	224.8	293.9	363.0
		Double acting	Push side	804.3	80.4	160.9	241.3	321.7	402.2	482.6	563.0
			Pull side	691.2	69.1	138.2	207.4	276.5	345.6	414.7	483.8
40	16	Single acting	Push side	1256.6	-	62.8	188.4	314.0	439.6	565.2	690.8
			Pull side	1055.6	-	22.6	128.1	233.6	339.1	444.6	550.1
		Double acting	Push side	1256.6	125.7	251.3	377.0	502.6	628.3	754.0	879.6
			Pull side	1055.6	105.6	211.1	316.7	422.2	527.8	633.4	738.9
50	16	Double acting	Push side	1962.5	196.3	392.5	588.8	785.0	981.3	1177.5	1373.8
		Pull side	1761.5	176.2	352.3	528.5	704.6	880.8	1056.9	1233.1	
63	16	Double acting	Push side	3115.7	311.6	623.1	934.7	1246.3	1557.9	1869.4	2181.0
		Pull side	2914.7	291.5	582.9	874.4	1165.9	1457.4	1748.8	2040.3	

Installation and application



- When load changes in the work, the cylinder with abundant output capacity shall be selected.
- Relative cylinder with high temperature resistance or corrosion resistance shall be chosen under the condition of high temperature or corrosion.
- Necessary protection measure shall be taken in the environment with higher humidity, much dust or water drops, oil dust and welding dregs.
- Dirty substances in the pipe must be eliminated before cylinder is connected with pipeline to prevent the entrance of particles into the cylinder.
- The medium used by cylinder shall be filtered to 40μm or below.
- Anti-freezing measure shall be adopted under low temperature environment to prevent moisture freezing.
- To avoid side load, otherwise, piston rod will be bent and deformed and damage the thread at the end of the rod. Single-acting type can not be added in return;
- If the cylinder is dismantled and stored for a long time, please to conduct anti-rust treatment to the surface. Anti-dust caps shall be added in air inlet and outlet ports. The front and back cover can not be dismantled, which shall be especially noticed.



Mini cylinder(Aluminum barrel)

MBL Series



Specification

Bore size(mm)		20	25	32	40	50	63	
Acting type	MSBL/MTBL	Single acting					-	
	MBL/MBLD/MBLJ	Double acting					-	
	MBLC/MBLCD/MBLCJ	Double acting with cushion					-	
Fluid		Air(to be filtered by 40µm filter element)						
Operating pressure	Double acting	0.15~1.0MPa(22~145psi)(1.5~10.0bar)					-	
	Single acting	0.2~1.0MPa(28~145psi)(2.0~10.0bar)					-	
Proof pressure		1.5MPa(215psi)(15bar)						
Temperature °C		-20~70						
Speed range mm/s		Double acting: 30~800					Single acting: 50~800	
Stroke tolerance		0~150 ^{+1.0} ₀					>150 ^{+1.5} ₀	
Cushion type		MBLC, MBLCD, MBLCJ: Adjustable cushion; Others: Bumper						
Port size [Note1]		1/8"				1/4"		

[Note1] PT thread, G thread and NPT thread are available.
Add) Refer to P353 for detail of sensor switch.

Symbol

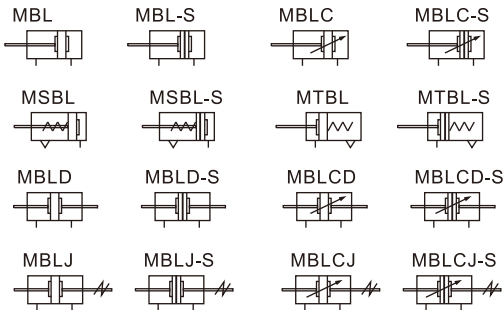

Stroke

Bore size (mm)	Standard stroke (mm)																Max.std stroke	Max. stroke								
	20/25	10	15	20	25	30	40	50	60	75	80	100	125	150	160	175			200	250	300	350	400	450	500	
MBL MBLC	20/25	10	15	20	25	30	40	50	60	75	80	100	125	150	160	175	200	250	300	350	400	450	500	500	800	
	32/40	10	15	20	25	30	40	50	60	75	80	100	125	150	160	175	200	250	300	350	400	450	500	500	800	
	50/63	10	15	20	25	30	40	50	60	75	80	100	125	150	160	175	200	250	300	350	400	450	500	500	800	
MBLD MBLJ MBLCD MBLCJ	20/25	10	15	20	25	30	40	50	60	75	80	100	125	150	160	175	200	250	300	350	400	450	500	300	-	
	32/40	10	15	20	25	30	40	50	60	75	80	100	125	150	160	175	200	250	300	350	400	450	500	500	-	
	50/63	10	15	20	25	30	40	50	60	75	80	100	125	150	160	175	200	250	300	350	400	450	500	500	-	
MSBL	20/25	10	15	20	25	30	40	50	60	75	80	100	125	150											-	-
	32/40	10	15	20	25	30	40	50	60	75	80	100	125	150											-	-
MTBL	20/25	10	15	20	25	30	40	50	60	75	80	100											-	-		
	32/40	10	15	20	25	30	40	50	60	75	80	100											-	-		

[Note] Consult us for non-standard stroke.

Product feature

1. Manufactured by our enterprise.
2. Riveted structure is adopted to connect front and bak cover and cylinder tube to make it credibility.
3. Piston adopts heterogeneous two-way seal structure. It has compact size and has the function of grease reservation.
4. There are several modes of back cover, which makes the installation of cylinder more convenient.
5. There are cylinders and mounting accessories with several specifications for your choice.

Ordering code

MBL 20 x 50 S CA
MBLD 20 x 50 S
MBLJ 20 x 50-20 S

① ② ③ ④ ⑤ ⑥ ⑦ ⑧

① Model	② Bore size	③ Stroke	④ Adjustable Stroke	⑤ Magnet	⑥ Back cover	⑦ Mounting type [Note1]	⑧ Thread type
MBL: Mini cylinder(Double acting)	20 25 32	Refer to stroke table for details	No this code	Blank: Without magnet S: With magnet	CA: Pivot type U: Flat-end type	Blank: No accessories FA: FA type SDB: SDB type LB: LB type	Blank: PT G: G T: NPT
MBLC: Mini cylinder(Double acting with cushion)	40 50 63						
MSBL: Mini cylinder(Single acting_push)	20 25 32 40						
MTBL: Mini cylinder(Single acting_pull)	20 25 32 40				No this code	Blank: No accessories FA: FA type LB: LB type	
MBLD: Mini cylinder(Double rod)	20 25 32						
MBLCD: Mini cylinder(Double rod with cushion)	20 25 32						
MBLJ: Mini cylinder(Adjustable stroke)	40 50 63		10 20 30 40				
MBLCJ: Mini cylinder(Adjustable stroke with cushion)	40 50 63		50 75 100				

[Note1] Please refer to page 100~101 for accessory parts.

Mini cylinder(Aluminum barrel)

MBL Series

Inner structure and material of major parts

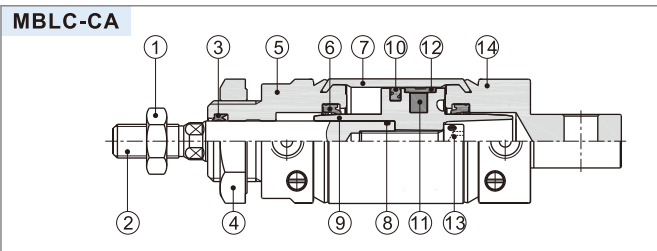

NO.	Item	Material
1	Rod nut	Carbon steel
2	Piston rod	Carbon steel with 20 μm chrome plated
3	Front cover packing	NBR
4	Front cover nut	Carbon steel
5	Front cover	Aluminum alloy
6	Bumper	TPU
7	Barrel	Aluminum alloy
8	O- ring	NBR
9	Piston	Aluminum alloy
10	Piston seal	NBR
11	Magnet	Plastic
12	Wear ring	Wear resistant material
13	Bolt	Carbon steel
14	Back cover	Aluminum alloy

Dimensions

MBL/MBLC

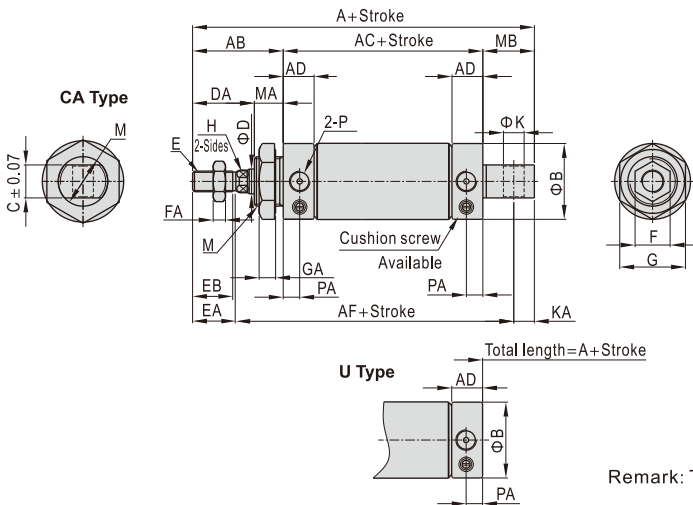

Bore size\Item	A		AB	AC	AD	AF	B	C	D	DA	M	MA	MB
	CA	U											
20	131	110	40	70	15.5	102	27	16	8	26	M22 × 1.5	14	21
25	135	114	44	70	15.5	105	30	16	10	30	M22 × 1.5	14	21
32	141	114	44	70	15.5	108	37	16	12	28	M24 × 2.0	16	27
40	165	138	46	92	22	130.5	45	20	16	30	M30 × 2.0	16	27
50	173	146	54	92	22	138	55	20	16	32	M36 × 2.0	22	27
63	173	146	54	92	22	138	68	20	16	32	M36 × 2.0	22	27

Bore size\Item	E	EA	EB	F	FA	G	GA	H	P	K	KA	PA
25	M10 × 1.25	21	19.5	17	6	29	7	8	1/8"	8	9	7.5
32	M10 × 1.25	21	19.5	17	6	32	8	10	1/8"	10	12	7.5
40	M12 × 1.25	22.5	21	17	7	41	8	14	1/4"	12	12	11
50	M14 × 1.5	24	22.5	19	8	46	11	14	1/4"	12	11	11
63	M14 × 1.5	24	22.5	19	8	46	11	14	1/4"	12	11	11

Remark: The dimensions of magnet type cylinder are the same as non-magnet type cylinder.

MSBL

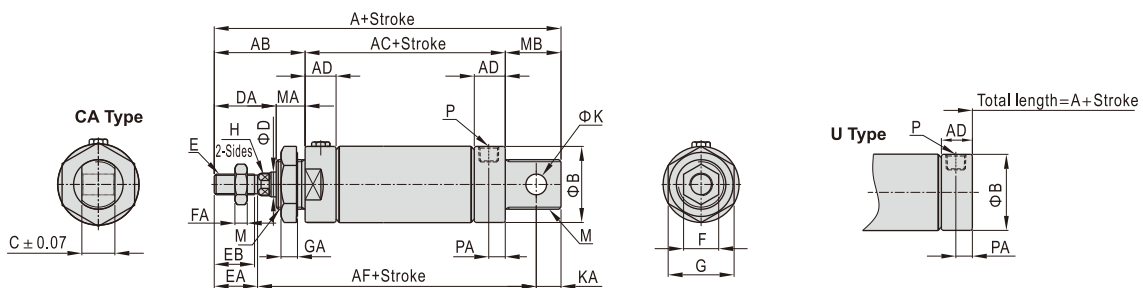

Item	A						AB	AC			AD	AF			B	C
	CA			U				≤50	51~100	≥101		≤50	51~100	≥101		
Bore size\Stroke	≤50	51~100	≥101	≤50	51~100	≥101	40	95	120	145	15.5	127	152	177	27	16
20	156	181	206	135	160	185	40	95	120	145	15.5	127	152	177	27	16
25	160	185	210	139	164	189	44	95	120	145	15.5	130	155	180	30	16
32	166	191	216	139	164	189	44	95	120	145	15.5	133	158	183	37	16
40	190	215	240	163	188	213	46	117	142	167	22	155.5	180.5	205.5	45	20

Bore size\Item	D	DA	E	EA	EB	F	FA	G	GA	H	K	KA	M	MA	MB	P	PA
25	10	30	M10 × 1.25	21	19.5	17	6	29	7	8	8	9	M22 × 1.5	14	21	1/8"	7.5
32	12	28	M10 × 1.25	21	19.5	17	6	32	8	10	10	12	M24 × 2.0	16	27	1/8"	7.5
40	16	30	M12 × 1.25	22.5	21	17	7	41	8	14	12	12	M30 × 2.0	16	27	1/4"	11

Remark: The dimensions of magnet type cylinder are the same as non-magnet type cylinder.

Mini cylinder(Aluminum barrel)

MBL Series

MTBL

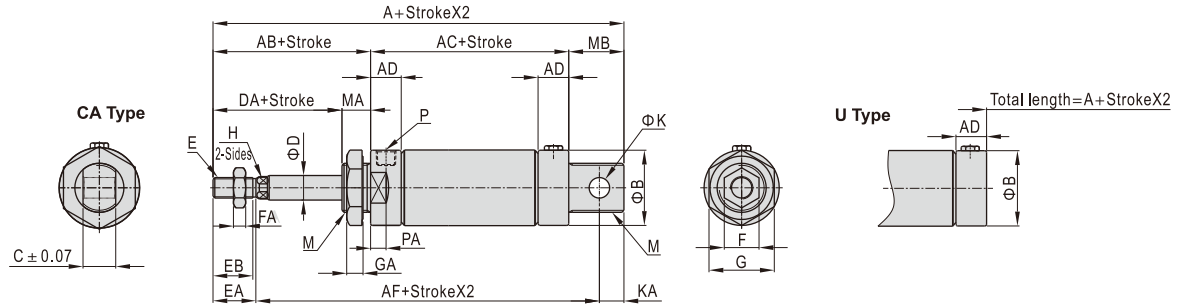

Item	A				AB	AC		AD	AF		B	C	D	DA
	CA		U			≤50	51~100		≤50	51~100				
Bore size\Stroke	≤50	51~100	≤50	51~100										
20	156	181	135	160	40	95	120	15.5	127	152	27	16	8	26
25	160	185	139	164	44	95	120	15.5	130	155	30	16	10	30
32	166	191	139	164	44	95	120	15.5	133	158	37	16	12	28
40	190	215	163	188	46	117	142	22	155.5	180.5	45	20	16	30

Bore size\Item	E	EA	EB	F	FA	G	GA	H	K	KA	M	MA	MB	P	PA
20	M8 × 1.25	20	18.5	12	6	29	7	6	8	9	M22 × 1.5	14	21	1/8"	7.5
25	M10 × 1.25	21	19.5	17	6	29	7	8	8	9	M22 × 1.5	14	21	1/8"	7.5
32	M10 × 1.25	21	19.5	17	6	32	8	10	10	12	M24 × 2.0	16	27	1/8"	7.5
40	M12 × 1.25	22.5	21	17	7	41	8	14	12	12	M30 × 2.0	16	27	1/4"	11

Remark: The dimensions of magnet type cylinder are the same as non-magnet type cylinder.

MBLD/MBLCD

MBLJ/MBLCJ

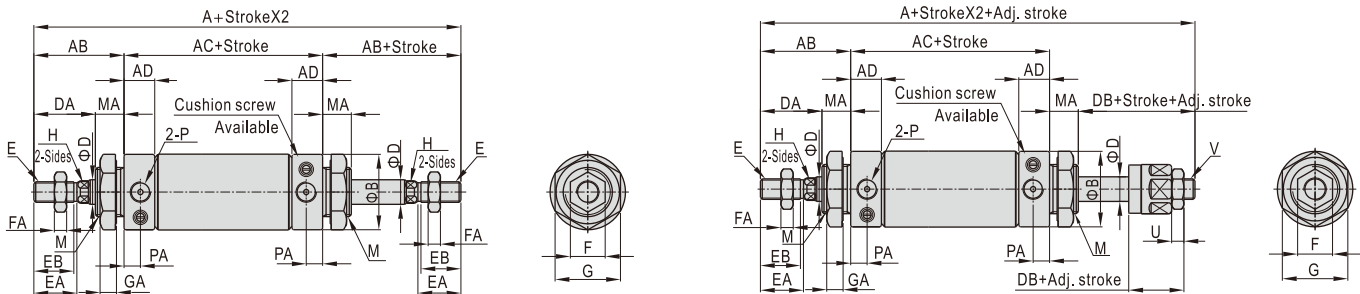

Bore size\Item	A				AB	AC	AD	B	D	DA	DB	E
	MBLD	MBLCD	MBLJ	MBLCJ								
20		150		149	40	70	15.5	27	8	26	25	M8 × 1.25
25		158		155	44	70	15.5	30	10	30	27	M10 × 1.25
32		158		157	44	70	15.5	37	12	28	27	M10 × 1.25
40		184		182	46	92	22	45	16	30	28	M12 × 1.25
50		200		196	54	92	22	55	16	32	28	M14 × 1.5
63		200		196	54	92	22	68	16	32	28	M14 × 1.5

Bore size\Item	EA	EB	F	FA	G	GA	H	M	MA	P	PA	U	V
20	20	18.5	12	6	29	7	6	M22 × 1.5	14	1/8"	7.5	6	M8 × 1.25
25	21	19.5	17	6	29	7	8	M22 × 1.5	14	1/8"	7.5	6	M10 × 1.25
32	21	19.5	17	6	32	8	10	M24 × 2.0	16	1/8"	7.5	6	M10 × 1.25
40	22.5	21	17	7	41	8	14	M30 × 2.0	16	1/4"	11	7	M12 × 1.25
50	24	22.5	19	8	46	11	14	M36 × 2.0	22	1/4"	11	7	M12 × 1.25
63	24	22.5	19	8	46	11	14	M36 × 2.0	22	1/4"	11	7	M12 × 1.25

Remark: The dimensions of magnet type cylinder are the same as non-magnet type cylinder.

Mini cylinder(Aluminum barrel)

MBL Series—Accessories

List for ordering code of accessories

Accessories Bore size	Mounting accessories			Knuckle				Sensor switch				
	LB	FA	SDB	I	Y	F	U	CMSG	DMSG(S)			
20	F-MA20LB	F-MA20FA	F-MA20SDB	F-MA20I	F-MA20Y	F-M8X125F	F-M8X125U	CMSG	DMSG(S)			
25				F-MA25I	F-MA25Y	F-M10X125F	F-M10X125U					
32				F-MA32LB	F-MA32FA	F-MA32SDB	F-MA40I			F-MA40Y	F-M12X125F	F-M12X125U
40				F-MA40LB	F-MA40FA	F-MA40SDB	F-MAC50I			F-MAC50Y	F-M14X150F	F-M14X150U
50				F-MA50LB	F-MA50FA		F-M14X150F			F-M14X150U		
63	F-MA63LB											

Accessory selection

Cylinder model	Accessories	Mounting accessories			Knuckle[Note1]				Sensor switch	
		LB	FA	SDB	I	Y	U	F	CMSG	DMSG(S)
MBL	Standard	●	●	●	●	●	●	●	×	×
	With magnet	●	●	●	●	●	●	●	●	●
MSBL	Standard	●	●	●	●	●	●	●	×	×
MTBL	With magnet	●	●	●	●	●	●	●	●	●
MBLD	Standard	●	●	×	●	●	●	●	×	×
	With magnet	●	●	×	●	●	●	●	●	●
MBLCD	Standard	●	●	×	●	●	●	●	×	×
	With magnet	●	●	×	●	●	●	●	●	●
MBLJ	Standard	●	●	×	●	●	●	●	×	×
MBLCJ	With magnet	●	●	×	●	●	●	●	●	●

Material of accessories

Accessories Bore size	Mounting accessories			Knuckle			
	LB	FA	SDB	I	Y	F	U
20~63	○	○	○	□	□	□	□

○—Lower carbon steel; □—Carbon steel;

[Note1] Please refer to P349~352 for knuckle detail.

Dimensions

LB

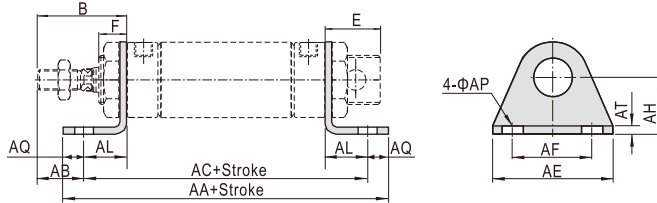

Bore size/Item Stroke	AA	AA(MSBL)			AC	AC(MSBL)		
	(MBL)	0~50	51~100	101~150	(MBL)	0~50	51~100	101~150
20	116	141	166	191	100	125	150	175
25	116	141	166	191	100	125	150	175
32	136	161	186	211	120	145	170	195
40	158	183	208	233	142	167	192	217
50	172	-	-	-	148	-	-	-
63	180	-	-	-	154	-	-	-

Bore size/Item	B	E	F	AB	AE	AF	AL	AQ	AP	AT	AH
20	40	21	14	25	54	40	15	8	6.5	3	25
25	44	21	14	29	54	40	15	8	6.5	3	25
32	44	27	16	19	59	45	25	8	7	3.5	32
40	46	27	16	21	64	50	25	8	7	3.5	36
50	54	27	22	26	86	66	28	12	11	4.5	40
63	54	27	22	23	106	82	31	13	11	4.5	45

FA

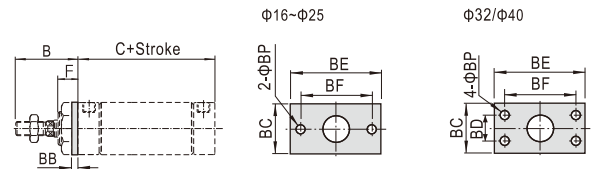

Bore size/Item Stroke	B	C	C(MSBL)			BB	BC	BD	BE	BF	BP	F
	(MBL)	0~50	51~100	101~150								
20	40	70	95	120	145	3.5	38	-	64	50	7	14
25	44	70	95	120	145	3.5	38	-	64	50	7	14
32	44	70	95	120	145	4	47	33	72	58	6.5	16
40	46	92	117	142	167	4	50	36	84	70	6.5	16
50	54	92	-	-	-	4.5	65	47	104	86	9	22
63	54	92	-	-	-	4.5	65	47	104	86	9	22

SDB

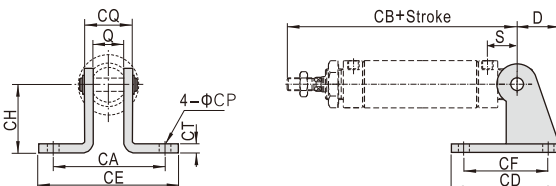

Bore size/Item Stroke	D	S	Q	CA	CB	CB(MSBL)			CD	CE	CF	CH	CT	CP	CQ
	(MBL)	0~50	51~100	101~150											
20	21	12	16	51	122	147	172	197	48	67	32	32	2.5	7	22
25	21	12	16	51	126	151	176	201	48	67	32	32	2.5	7	22
32	27	15	16	51	129	154	179	204	52	67	36	36	3	7	24
40	27	15	20	55	153	178	203	228	56	71	40	40	3	7	28

[Note] SDB is attached with relevant PIN.

Mini cylinder(Aluminum barrel)

MBL Series—Accessories

I Knuckle

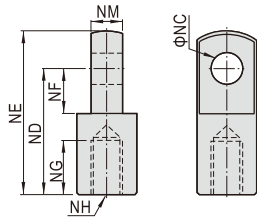

Type/Item	NC	ND	NE	NF	NH	NG	NM
F-MA20I	8	30	40	11	M8×1.25	15	8
F-MA25I	10	40	50	15	M10×1.25	20	10
F-MA40I	10	45	57	16	M12×1.25	23	14

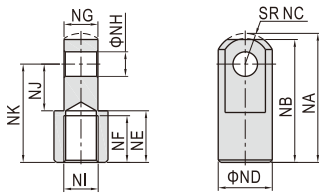

Type/Item	NA	NB	NC	ND	NE	NF	NG	NH	NJ	NK	NI
F-MAC50I	52.5	50	12.5	22	21	19	13.8	10	19	40	M14×1.5

Y Knuckle

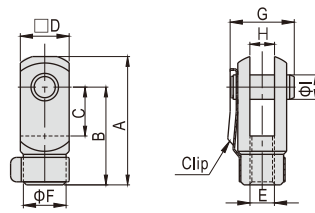

Type/Item	A	B	C	D	E	F	G	H	I
F-MA20Y	42	32	16	16	M8×1.25	14	21	8	8
F-MA25Y	52	40	20	19	M10×1.25	18	25	10	10

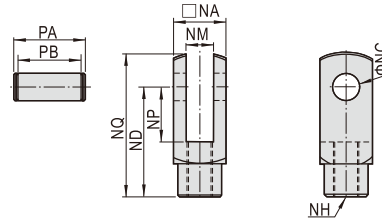

Type/Item	NA	NC	ND	NP	NQ	NM	NH	PA	PB
F-MA40Y	25.4	10	45	20	57	14	M12×1.25	32	26.2

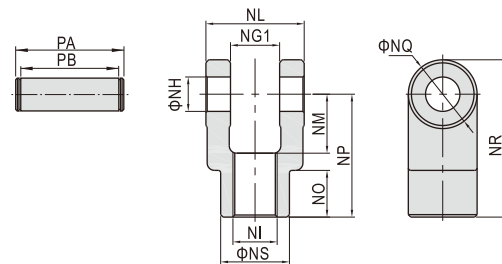

Type/Item	Ng1	NH	NI	NL	NM	NO	NP	NQ	NR	NS	PA	PB
F-MAC50Y	14.2	10	M14×1.5	27.8	19	17	40	22	51	22	34.6	28.8