

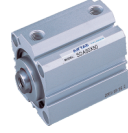





Compact cylinder——SDA Series

Product series

Series name	Acting type	Bore size	Collocation of sensor switch			
			CS1-J	DS1-J	CS1-G	DS1-G
Double acting type: SDA 	Double acting	12	●	●		
Adjustable stroke type: SDAJ 		16	●	●		
Double rod type: SDAD 		20	●	●	●	●
		25	●	●	●	●
Duplex type: SDAT Duplex-end type: SDAW 		32	●	●	●	●
		40	●	●	●	●
Single acting type: SSA, STA 		50	●	●	●	●
		63	●	●	●	●
		80	●	●	●	●
		100	●	●	●	●
	Single acting	12	●	●		
		16	●	●		
		20	●	●	●	●
		25	●	●	●	●
		32	●	●	●	●
		40	●	●	●	●
		50	●	●	●	●
	63	●	●	●	●	
Page	284		403			

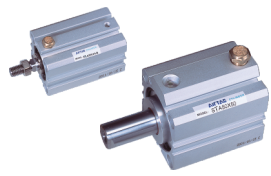
SDA

Installation and application

- When load changes in the work, the cylinder with abundant output capacity shall be selected.
- Relative cylinder with high temperature resistance or corrosion resistance shall be chosen under the condition of high temperature or corrosion.
- Necessary protection measure shall be taken in the environment with higher humidity, much dust or water drops, oil dust and welding dregs.
- Dirty substances in the pipe must be eliminated before cylinder is connected with pipeline to prevent the entrance of particles into the cylinder.
- The medium used by cylinder shall be filtered to 40 μm or below.
- As both of the front cover and piston of the cylinder are short, typically too large stroke can not be selected.
- Anti-freezing measure shall be adopted under low temperature environment to prevent moisture freezing.
- The cylinder shall avoid the influence of side load in operation to maintain the normal work of cylinder and extend the service life.
- If the cylinder is dismantled and stored for a long time, please conduct anti-rust treatment to the surface. Anti-dust caps shall be added in air inlet and outlet ports. The front and back cover can not be dismantled, which shall be especially noticed.

Criteria for selection: Cylinder thrust

Unit: Newton(N)

Bore size (mm)	Rod size (mm)	Acting type	Pressure area (mm ²)	Operating pressure(MPa)							Bore size (mm)	Rod size (mm)	Acting type	Pressure area (mm ²)	Operating pressure(MPa)								
				0.1	0.2	0.3	0.4	0.5	0.6	0.7					0.1	0.2	0.3	0.4	0.5	0.6	0.7		
12	6	Single acting	Push side	131.1	-	12.6	23.9	35.2	46.5	57.9	69.2	40	16	Single acting	Push side	1256.6	-	168.6	294.3	420.0	545.6	671.3	796.9
			Pull side	84.8	-	7.0	15.4	23.9	32.4	40.9	49.4				Pull side	1055.6	-	128.4	234.0	339.5	445.1	550.6	656.2
		Double acting	Push side	131.1	-	22.6	33.9	45.2	56.5	67.9	79.2			Double acting	Push side	1256.6	125.7	251.3	377.0	502.7	628.3	754.0	879.6
			Pull side	84.8	-	17.0	25.4	33.9	42.4	50.9	59.4				Pull side	1055.6	105.6	211.1	316.7	422.2	527.8	633.3	738.9
16	6	Single acting	Push side	201.1	-	20.2	40.3	60.4	80.5	100.6	120.7	50	20	Single acting	Push side	1963.5	89.3	285.7	482.0	678.4	874.7	1071.1	1267.4
			Pull side	172.8	-	14.6	31.8	49.1	66.4	83.7	101.0				Pull side	1649.3	57.9	222.9	387.8	552.7	717.7	882.6	1047.5
		Double acting	Push side	201.1	-	40.2	60.3	80.4	100.5	120.6	140.7			Double acting	Push side	1963.5	196.3	392.7	589.0	785.4	981.7	1178.1	1374.4
			Pull side	172.8	-	34.6	51.8	69.1	86.4	103.7	121.0				Pull side	1649.3	164.9	329.9	494.8	659.7	824.7	989.6	1154.5
20	8	Single acting	Push side	314.2	-	39.8	71.2	102.7	134.1	165.5	196.9	63	20	Single acting	Push side	3117.2	135.7	447.4	759.2	1070.9	1382.6	1694.3	2006.1
			Pull side	263.9	-	29.8	56.2	82.6	108.9	135.3	161.7				Pull side	2803.1	104.3	384.6	664.9	945.2	1225.5	1505.9	1786.2
		Double acting	Push side	314.2	-	62.8	94.2	125.7	157.1	188.5	219.9			Double acting	Push side	3117.2	311.7	623.4	935.2	1246.9	1558.6	1870.3	2182.1
			Pull side	263.9	-	52.8	79.2	105.6	131.9	158.3	184.7				Pull side	2803.1	280.3	560.6	840.9	1121.2	1401.5	1681.9	1962.2
25	10	Single acting	Push side	490.9	-	69.7	118.8	167.8	216.9	266.0	315.1	80	25	Double acting	Push side	5026.5	502.7	1005.3	1508.0	2010.6	2513.3	3015.9	3518.6
			Pull side	412.3	-	54.0	95.2	136.4	177.7	218.9	260.1				Pull side	4535.7	453.6	907.1	1360.7	1814.3	2267.8	2721.4	3175.0
		Double acting	Push side	490.9	-	98.2	147.3	196.3	245.4	294.5	343.6			Double acting	Push side	7854.0	785.4	1570.8	2356.2	3141.6	3927.0	4712.4	5497.8
			Pull side	412.3	-	82.5	123.7	164.9	206.2	247.4	288.6				Pull side	7049.7	705.0	1409.9	2114.9	2819.9	3524.9	4229.8	4934.8
32	12	Single acting	Push side	804.2	-	105.3	185.8	266.2	346.6	427.0	507.5	100	32	Single acting	Push side	691.2	-	82.7	151.8	221.0	290.1	359.2	428.3
			Pull side	691.2	-	82.7	151.8	221.0	290.1	359.2	428.3				Pull side	691.2	-	82.7	151.8	221.0	290.1	359.2	428.3
		Double acting	Push side	804.2	-	160.8	241.3	321.7	402.1	482.5	563.0			Double acting	Push side	804.2	-	160.8	241.3	321.7	402.1	482.5	563.0
			Pull side	691.2	-	138.2	207.3	276.5	345.6	414.7	483.8				Pull side	691.2	-	138.2	207.3	276.5	345.6	414.7	483.8



Compact cylinder



SDA Series

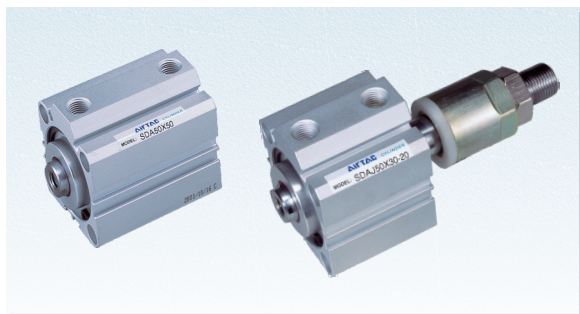

Symbol

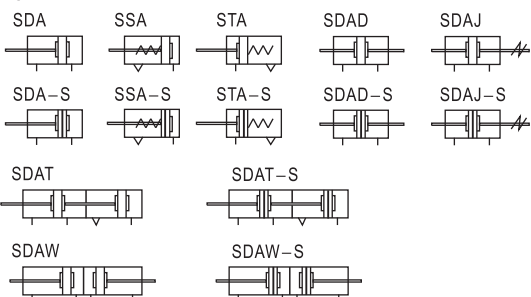

Product feature

1. Manufactured by our enterprise.
2. Riveted structure is adopted to connect the cylinder body and back cover, and piston and piston rod to make it compact and reliable;
3. The inner diameter of the body is treated with rolling followed by the treatment of hard anodizing, forming an excellent abrasion resistance and durability.
4. The seal of piston adopts heterogeneous two-way seal structure. It has compact dimension and the function of grease reservation.
5. Compact structure can effectively save installation space.
6. There are magnetic switch slots around the cylinder body, which is convenient to install sensor switch
7. Mounting accessories with various specifications are optional.

Ordering code

Model can be changed Ordering code. Example:
 Production type: SDAJ
 Magnet: With magnet
 Bore size: 50mm
 Stroke: 80mm
 Adjustable stroke: 50mm
 Rod type: Male thread
 Thread type: NPT

Model: SDAJ S-50 × 80-50-B-T

Ordering code: SDAJ S 50 0080 050 B T

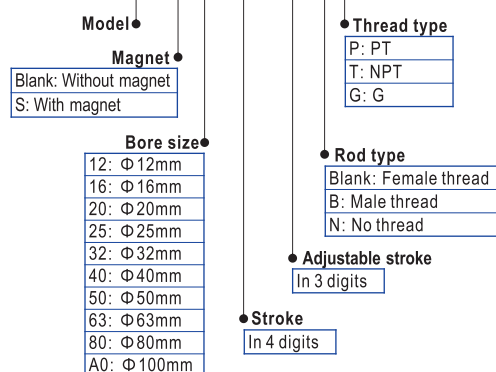

Specification

Bore size(mm)	12	16	20	25	32	40	50	63	80	100	
Acting type	Double acting										
	Single acting-Push type, Single acting-Pull type										
Fluid	Air(to be filtered by 40 μ m filter element)										
Operating pressure	0.1~1.0MPa(15~145psi)(1.0~10.0bar)										
	0.2~1.0MPa(28~145psi)(2.0~10.0bar)										
Proof pressure	1.5MPa(215psi)(15bar)										
Temperature °C	-20~80										
Speed range mm/s	Double acting: 30~500					Single acting: 50~500					
Stroke tolerance											
Cushion type	Bumper										
Port size ①	M5 × 0.8					1/8"		1/4"		3/8"	

① PT thread, NPT thread and G thread are available. Add) Refer to P403~426 for detail of sensor switch.

Stroke

Bore size (mm)	Acting type	Magnet	Standard stroke (mm)										Max. std. stroke	Max. stroke												
			5	10	15	20	25	30	35	40	45	50			55	60	65	70	75	80	85	90	100	110	120	130
12	Double acting	With magnet	5	10	15	20	25	30	35	40	45	50													50	70
		Without magnet	5	10	15	20	25	30	35	40	45	50	55	60											60	80
16	Single acting	With magnet	5	10	15	20	25	30																30	-	
		Without magnet	5	10	15	20	25	30	35	40	45	50	55	60	65	70	75	80	85	90				90	130	
20	Double acting	With magnet	5	10	15	20	25	30	35	40	45	50	55	60	65	70	75	80	85	90	100	110	120		120	150
		Without magnet	5	10	15	20	25	30	35	40	45	50	55	60	65	70	75	80	85	90	100	110	120	130	130	160
25, 32, 40, 50	Single acting	With magnet	5	10	15	20	25	30																30	-	
		Without magnet	5	10	15	20	25	30	35	40	45	50	55	60	65	70	75	80	85	90	100	110	120	130	130	160
63	Single acting	With magnet	5	10	15	20	25	30																30	-	
		Without magnet	5	10	15	20	25	30	35	40	45	50	55	60	65	70	75	80	85	90	100	110	120	130	130	160
80	Double acting	With magnet	5	10	15	20	25	30	35	40	45	50	55	60	65	70	75	80	85	90	100	110	120		120	150
		Without magnet	5	10	15	20	25	30	35	40	45	50	55	60	65	70	75	80	85	90	100	110	120	130	130	160
100	Single acting	With magnet	5	10	15	20	25	30																30	-	
		Without magnet	5	10	15	20	25	30	35	40	45	50	55	60	65	70	75	80	85	90	100	110	120	130	130	160

Note) 1. Please contact the company for other special strokes.

2. The dimensions of non-std stroke cylinder has the same dimensions as the next longer stroke std. stroke cylinder. e.g. 23mm stroke cylinder has the same dimensions of 25 std. stroke cylinder.

Explain of model

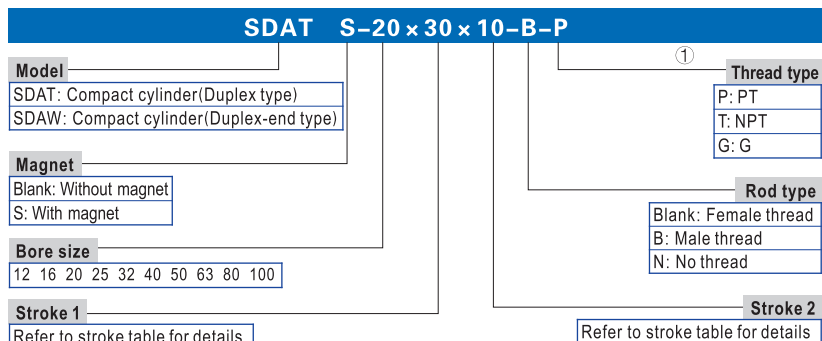
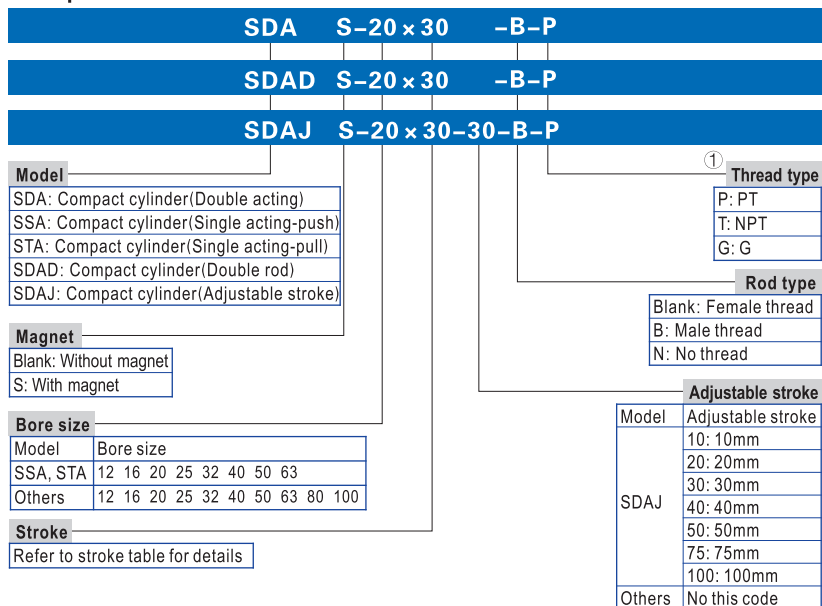

① Standard thread is blank here.



Compact cylinder



SDA Series

Inner structure and material of major parts

SDA

NO.	Item	Material
1	Back cover	No(Φ 12, 16) Aluminum alloy(Others)
2	Bumper	NBR
3	Piston	Brass(Φ 12, 16) Aluminum alloy(Others)
4	Piston seal	NBR
5	Piston rod	Carbon steel with 20 μ m chrome plated
6	Body	Aluminum alloy
7	Front cover	Aluminum alloy
8	O-ring	NBR
9	C clip	Spring steel
10	Front cover packing	NBR
11	Piston nut	Carbon steel
12	Bushing	No(Φ 12~32) Wear resistant material(Others)

Dimensions

SDA

Item	A		C		B1	D	E	F	G	K1	L	M	N1		N2	
	Standard	With magnet	Standard	With magnet									St=5	St>5	St=5	St>5
12	22	32	17	27	5	-	6	4	1	M3 × 0.5	10.2	3	7.5	7.5	5	5
16	24	34	18.5	28.5	5.5	-	6	4	1.5	M3 × 0.5	11	3	8	8	5.5	5.5
20	25	35	19.5	29.5	5.5	36	8	4	1.5	M4 × 0.7	13	3	9	9	5.5	5.5
25	27	37	21	31	6	42	10	4	2	M5 × 0.8	17	3	9.2	9.2	5.5	5.5
32	31.5	41.5	24.5	34.5	7	50	12	4.6	2.4	M6 × 1.0	22	3	9	9	6.5	9
40	33	43	26	36	7	58.5	12	4	3	M8 × 1.25	28	3	9.5	9.5	7.5	7.5
50	37	47	28	38	9	71.5	15	5	4	M10 × 1.5	38	3	8	10.5	8	10.5
63	41	51	32	42	9	84.5	15	5	4	M10 × 1.5	40	3	9.5	12	9.5	11
80	52	62	41	51	11	104	20	6	5	M14 × 1.5	45	4	11.5	14.5	11.5	14.5
100	63	73	51	61	12	124	20	7	5	M18 × 1.5	55	4	16	20.5	16	20.5

Bore size\Item	O	P1	P3	P4	R	S	T1	T2	V	W	X	Y
12	M5 × 0.8	2-Sides: Φ 6.5 Thread:M5 × 0.8 Thru.hole: Φ 4.2	12	4.5	-	25	16.2	23	6	5	-	-
16	M5 × 0.8	2-Sides: Φ 6.5 Thread:M5 × 0.8 Thru.hole: Φ 4.2	12	4.5	-	29	19.8	28	6	5	-	-
20	M5 × 0.8	2-Sides: Φ 6.5 Thread:M5 × 0.8 Thru.hole: Φ 4.2	14	4.5	2	34	24	-	8	6	11.3	10
25	M5 × 0.8	2-Sides: Φ 8.2 Thread:M6 × 1.0 Thru.hole: Φ 4.6	15	5.5	2	40	28	-	10	8	12	10
32	1/8"	2-Sides: Φ 8.2 Thread:M6 × 1.0 Thru.hole: Φ 4.6	16	5.5	6	44	34	-	12	10	18.3	15
40	1/8"	2-Sides: Φ 10 Thread:M8 × 1.25 Thru.hole: Φ 6.5	20	7.5	6.5	52	40	-	16	14	21.7	16
50	1/4"	2-Sides: Φ 11 Thread:M8 × 1.25 Thru.hole: Φ 6.5	25	8.5	9.5	62	48	-	20	17	30	20
63	1/4"	2-Sides: Φ 11 Thread:M8 × 1.25 Thru.hole: Φ 6.5	25	8.5	9.5	75	60	-	20	17	28.7	20
80	3/8"	2-Sides: Φ 14 Thread:M12 × 1.75 Thru.hole: Φ 9.2	25	10.5	10	94	74	-	25	22	36	26
100	3/8"	2-Sides: Φ 17.5 Thread:M14 × 2.0 Thru.hole: Φ 11.3	30	13	10	114	90	-	32	27	35	26

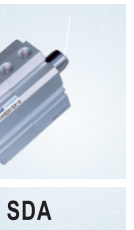

Compact cylinder



SDA Series

SSA

Φ 12 Φ 16

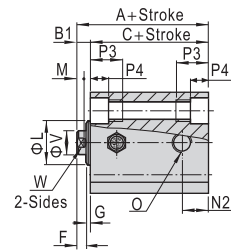
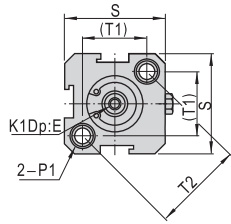

Φ 20~Φ 63

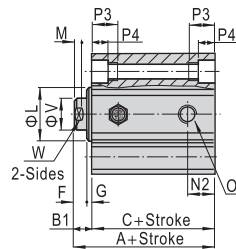
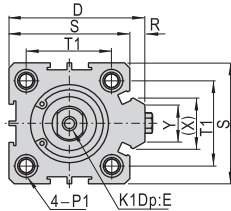

STA

Φ 12 Φ 16

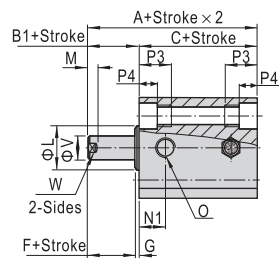
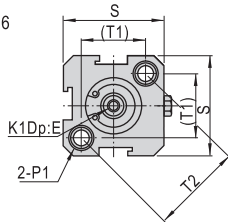

Φ 20~Φ 63

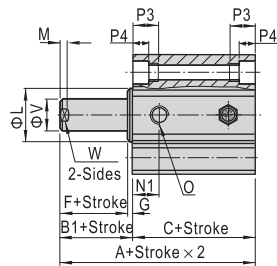
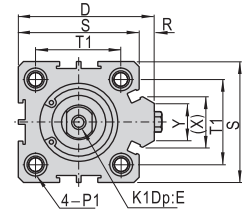

Bore size\Item	A(Standard)		A(With magnet)		C(Standard)		C(With magnet)		B1	D	E
	St≤10	St>10	St≤10	St>10	St≤10	St>10	St≤10	St>10			
12	32	42	42	52	27	37	37	47	5	-	6
16	34	44	44	54	28.5	38.5	38.5	48.5	5.5	-	6
20	35	45	45	55	29.5	39.5	39.5	49.5	5.5	36	8
25	37	47	47	57	31	41	41	51	6	42	10
32	41.5	51.5	51.5	61.5	34.5	44.5	44.5	54.5	7	50	12
40	43	53	53	63	36	46	46	56	7	58.5	12
50	47	57	57	67	38	48	48	58	9	71.5	15
63	51	61	61	71	42	52	52	62	9	84.5	15

Bore size\Item	F	G	K1	L	M	N1	N2	O	R	S	T1	T2
16	4	1.5	M3 × 0.5	11	3	8	5.5	M5 × 0.8	-	29	19.8	28
20	4	1.5	M4 × 0.7	13	3	9	5.5	M5 × 0.8	2	34	24	-
25	4	2	M5 × 0.8	17	3	9.2	5.5	M5 × 0.8	2	40	28	-
32	4	2.4	M6 × 1.0	22	3	9	9	1/8"	6	44	34	-
40	4	3	M8 × 1.25	28	3	9.5	7.5	1/8"	6.5	52	40	-
50	5	4	M10 × 1.5	38	3	10.5	10.5	1/4"	9.5	62	48	-
63	5	4	M10 × 1.5	40	3	12	11	1/4"	9.5	75	60	-

Bore size\Item	P1	P3	P4	V	W	X	Y
16	2-Sides: Φ 6.5 Thread: M5 × 0.8 Thru.hole: Φ 4.2	12	4.5	6	5	-	-
20	2-Sides: Φ 6.5 Thread: M5 × 0.8 Thru.hole: Φ 4.2	14	4.5	8	6	11.3	10
25	2-Sides: Φ 8.2 Thread: M6 × 1.0 Thru.hole: Φ 4.6	15	5.5	10	8	12	10
32	2-Sides: Φ 8.2 Thread: M6 × 1.0 Thru.hole: Φ 4.6	16	5.5	12	10	18.3	15
40	2-Sides: Φ 10 Thread: M8 × 1.25 Thru.hole: Φ 6.5	20	7.5	16	14	21.7	16
50	2-Sides: Φ 11 Thread: M8 × 1.25 Thru.hole: Φ 6.5	25	8.5	20	17	30	20
63	2-Sides: Φ 11 Thread: M8 × 1.25 Thru.hole: Φ 6.5	25	8.5	20	17	28.7	20

Male thread

Φ 12 Φ 16

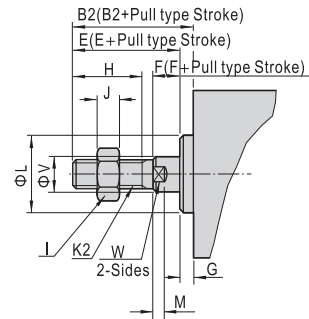

Φ 20~Φ 100

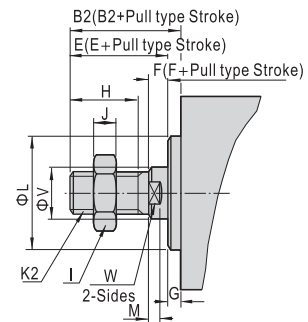

Bore size\Item	B2	E	F	G			H	I
				SDAD,SDAJ	Others			
12	17	16	4	1	1	10	8	
16	17.5	16	4	1.5	1.5	10	8	
20	20.5	19	4	1.5	1.5	13	10	
25	23	21	4	2	2	15	12	
32	25	22	4	3	2.4	15	17	
40	35	32	4	3	3	25	19	
50	37	33	5	4	4	25	27	
63	37	33	5	4	4	25	27	
80	44	39	6	5	5	30	32	
100	50	45	7	5	5	35	36	

Bore size\Item	J	K2	L	M	V	W
16	4	M5 × 0.8	11	3	6	5
20	5	M6 × 1.0	13	3	8	6
25	6	M8 × 1.25	17	3	10	8
32	6	M10 × 1.25	22	3	12	10
40	8	M14 × 1.5	28	3	16	14
50	11	M18 × 1.5	38	3	20	17
63	11	M18 × 1.5	40	3	20	17
80	13	M22 × 1.5	45	4	25	22
100	13	M26 × 1.5	55	4	32	27



Compact cylinder

SDA Series



SDAD

Φ12 Φ16

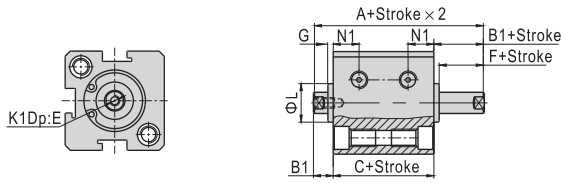

Φ20~Φ100

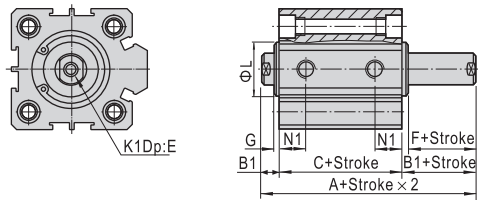

Item	A		C		E	
	Standard	With magnet	Standard	With magnet	St≤10	St>10
12	27	37	17	27	6	6
16	29.5	39.5	18.5	28.5	6	6
20	30.5	40.5	19.5	29.5	8(St=5 is 6.5)	
25	33	43	21	31	10(St=5 is 7)	
32	38.5	48.5	24.5	34.5	8	12
40	40	50	26	36	8	12
50	46	56	28	38	8	15
63	50	60	32	42	10	15
80	63	73	41	51	13	20
100	75	85	51	61	18	20

Item	N1		B1	F	G	K1	L
	St=5	St>5					
12	5.5	6.3	5	4	1	M3 × 0.5	10.2
16	6.5	7.3	5.5	4	1.5	M3 × 0.5	11
20	7.5	7.5	5.5	4	1.5	M4 × 0.7	15
25	8	8	6	4	2	M5 × 0.8	17
32	8	9	7	4	3	M6 × 1.0	22
40	8	10	7	4	3	M8 × 1.25	28
50	8	10.5	9	5	4	M10 × 1.5	38
63	9.5	11.8	9	5	4	M10 × 1.5	40
80	11.5	14.5	11	6	5	M14 × 1.5	45
100	16	20.5	12	7	5	M18 × 1.5	55

Note) The unmarked dimension is the same as SDA standard type.
Please refer to Page 286 for the dimension of male thread.

SDAJ

Φ12 Φ16

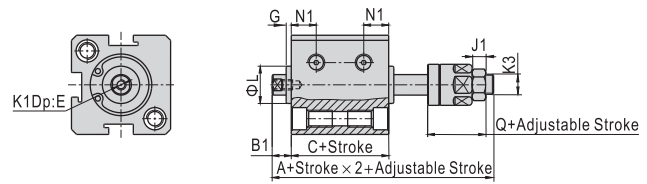

Φ20~Φ100

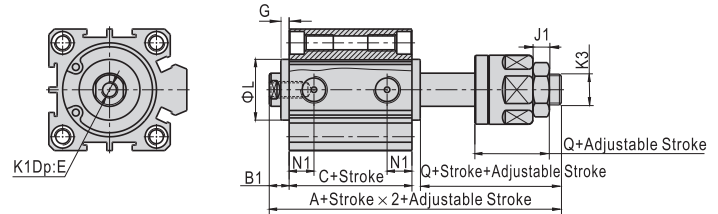

Item	A		C		E		N1	
	Standard	With magnet	Standard	With magnet	St≤10	St>10	St=5	St>5
12	40	50	17	27	6	6	5.5	6.3
16	42.5	52.5	18.5	28.5	6	6	6.5	7.3
20	47.5	57.5	19.5	29.5	8(St=5 is 6.5)		7.5	7.5
25	54	64	21	31	10(St=5 is 7)		8	8
32	61.5	71.5	24.5	34.5	8	12	8	9
40	64	74	26	36	8	12	8	10
50	70	80	28	38	8	15	8	10.5
63	74	84	32	42	10	15	9.5	11.8
80	92.5	102.5	41	51	13	20	11.5	14.5
100	110.5	120.5	51	61	18	20	16	20.5

Bore size\Item	B1	Q	G	J1	K1	K3	L
16	5.5	17	1.5	4	M3 × 0.5	M5 × 0.8	11
20	5.5	21	1.5	5	M4 × 0.7	M6 × 1.0	15
25	6	25	2	6	M5 × 0.8	M8 × 1.25	17
32	7	27	3	6	M6 × 1.0	M10 × 1.25	22
40	7	28	3	7	M8 × 1.25	M12 × 1.25	28
50	9	29	4	8	M10 × 1.5	M16 × 1.5	38
63	9	29	4	8	M10 × 1.5	M16 × 1.5	40
80	11	35.5	5	10	M14 × 1.5	M20 × 1.5	45
100	12	42.5	5	13.5	M18 × 1.5	M27 × 2.0	55

Note) The unmarked dimension is the same as SDA standard type.
Please refer to Page 286 for the dimension of male thread.



SDA

Compact cylinder



SDA Series

SDAT

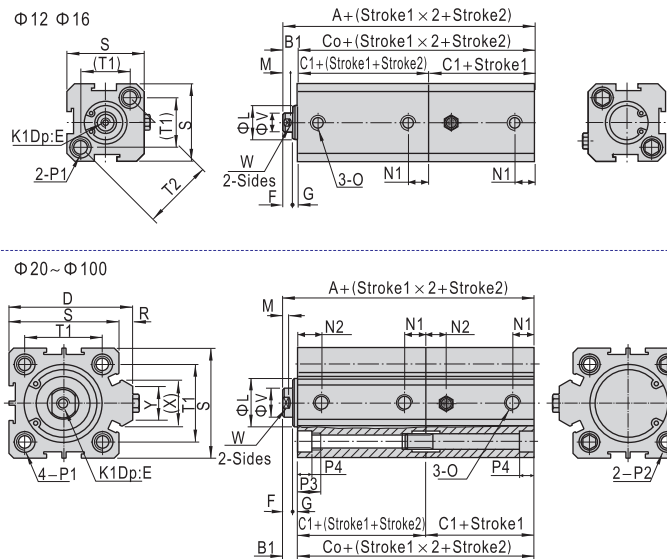

Note) Please refer to Page 286 for the dimension of male thread.

Item	A		Co		C1		N1		N2	
	Standard	With magnet	Standard	With magnet	Standard	With magnet	St=5	St>5	St=5	St>5
12	39	59	34	54	17	27	5	5	7.5	7.5
16	42.5	62.5	37	57	18.5	28.5	5.5	5.5	8	8
20	44.5	64.5	39	59	19.5	29.5	5.5	5.5	9	9
25	48	68	42	62	21	31	5.5	5.5	9.2	9.2
32	56	76	49	69	24.5	34.5	6.5	9	9	9
40	59	79	52	72	26	36	7.5	7.5	9.5	9.5
50	65	85	56	76	28	38	8	10.5	8	10.5
63	73	93	64	84	32	42	9.5	11	9.5	12
80	93	113	82	102	41	51	11.5	14.5	11.5	14.5
100	114	134	102	122	51	61	16	20.5	16	20.5

Bore size\Item	B1	D	E	F	G	K1	L	M	O	R
12	5	-	6	4	1	M3 x 0.5	10.2	3	M5 x 0.8	-
16	5.5	-	6	4	1.5	M3 x 0.5	11	3	M5 x 0.8	-
20	5.5	36	8	4	1.5	M4 x 0.7	13	3	M5 x 0.8	2
25	6	42	10	4	2	M5 x 0.8	17	3	M5 x 0.8	2
32	7	50	12	4	2.4	M6 x 1.0	22	3	1/8"	6
40	7	58.5	12	4	3	M8 x 1.25	28	3	1/8"	6.5
50	9	71.5	15	5	4	M10 x 1.5	38	3	1/4"	9.5
63	9	84.5	15	5	4	M10 x 1.5	40	3	1/4"	9.5
80	11	104	20	6	5	M14 x 1.5	45	4	3/8"	10
100	12	124	20	7	5	M18 x 1.5	55	4	3/8"	10

Bore size\Item	P1	P2
12	Φ 6.5 Thread:M5 x 0.8 Thru.hole: Φ 4.2	-
16	Φ 6.5 Thread:M5 x 0.8 Thru.hole: Φ 4.2	-
20	2-Sides: Φ 6.5 Thread:M5 x 0.8 Thru.hole: Φ 4.2	2-Sides: Φ 6.5 Thru.hole: Φ 5.2
25	2-Sides: Φ 8.2 Thread:M6 x 1.0 Thru.hole: Φ 4.6	2-Sides: Φ 8.2 Thru.hole: Φ 6.2
32	2-Sides: Φ 8.2 Thread:M6 x 1.0 Thru.hole: Φ 4.6	2-Sides: Φ 8.2 Thru.hole: Φ 6.2
40	2-Sides: Φ 10 Thread:M8 x 1.25 Thru.hole: Φ 6.5	2-Sides: Φ 10 Thru.hole: Φ 8.2
50	2-Sides: Φ 11 Thread:M8 x 1.25 Thru.hole: Φ 6.5	2-Sides: Φ 11 Thru.hole: Φ 8.5
63	2-Sides: Φ 11 Thread:M8 x 1.25 Thru.hole: Φ 6.5	2-Sides: Φ 11 Thru.hole: Φ 8.5
80	2-Sides: Φ 14 Thread:M12 x 1.75 Thru.hole: Φ 9.2	2-Sides: Φ 14 Thru.hole: Φ 12.3
100	2-Sides: Φ 17.5 Thread:M14 x 2.0 Thru.hole: Φ 11.3	2-Sides: Φ 17.5 Thru.hole: Φ 14.2

Bore size\Item	P3	P4	S	T1	T2	V	W	X	Y
12	12	4.5	25	16.2	23	6	5	-	-
16	12	4.5	29	19.8	28	6	5	-	-
20	14	4.5	34	24	-	8	6	11.3	10
25	15	5.5	40	28	-	10	8	12	10
32	16	5.5	44	34	-	12	10	18.3	15
40	20	7.5	52	40	-	16	14	21.7	16
50	25	8.5	62	48	-	20	17	30	20
63	25	8.5	75	60	-	20	17	28.7	20
80	25	10.5	94	74	-	25	22	36	26
100	30	13	114	90	-	32	27	35	26

SDAW

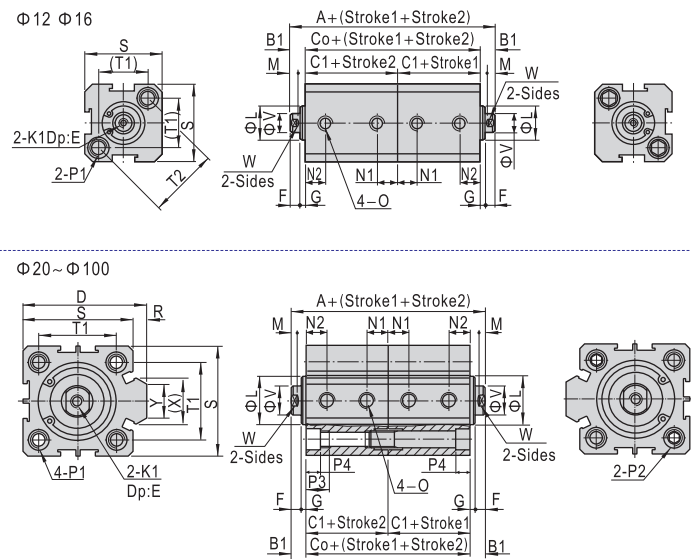

Note) Please refer to Page 286 for the dimension of male thread.

Item	A		Co		C1		N1		N2	
	Standard	With magnet	Standard	With magnet	Standard	With magnet	St=5	St>5	St=5	St>5
12	44	64	34	54	17	27	5	5	7.5	7.5
16	48	68	37	57	18.5	28.5	5.5	5.5	8	8
20	50	70	39	59	19.5	29.5	5.5	5.5	9	9
25	54	74	42	62	21	31	5.5	5.5	9.2	9.2
32	63	83	49	69	24.5	34.5	6.5	9	9	9
40	66	86	52	72	26	36	7.5	7.5	9.5	9.5
50	74	94	56	76	28	38	8	10.5	8	10.5
63	82	102	64	84	32	42	9.5	11	9.5	12
80	104	124	82	102	41	51	11.5	14.5	11.5	14.5
100	126	146	102	122	51	61	16	20.5	16	20.5

Bore size\Item	B1	D	E	F	G	K1	L	M	O	R
12	5	-	6	4	1	M3 x 0.5	10.2	3	M5 x 0.8	-
16	5.5	-	6	4	1.5	M3 x 0.5	11	3	M5 x 0.8	-
20	5.5	36	8	4	1.5	M4 x 0.7	13	3	M5 x 0.8	2
25	6	42	10	4	2	M5 x 0.8	17	3	M5 x 0.8	2
32	7	50	12	4	2.4	M6 x 1.0	22	3	1/8"	6
40	7	58.5	12	4	3	M8 x 1.25	28	3	1/8"	6.5
50	9	71.5	15	5	4	M10 x 1.5	38	3	1/4"	9.5
63	9	84.5	15	5	4	M10 x 1.5	40	3	1/4"	9.5
80	11	104	20	6	5	M14 x 1.5	45	4	3/8"	10
100	12	124	20	7	5	M18 x 1.5	55	4	3/8"	10

Bore size\Item	P1	P2
12	Φ 6.5 Thread:M5 x 0.8 Thru.hole: Φ 4.2	-
16	Φ 6.5 Thread:M5 x 0.8 Thru.hole: Φ 4.2	-
20	2-Sides: Φ 6.5 Thread:M5 x 0.8 Thru.hole: Φ 4.2	2-Sides: Φ 6.5 Thru.hole: Φ 5.2
25	2-Sides: Φ 8.2 Thread:M6 x 1.0 Thru.hole: Φ 4.6	2-Sides: Φ 8.2 Thru.hole: Φ 6.2
32	2-Sides: Φ 8.2 Thread:M6 x 1.0 Thru.hole: Φ 4.6	2-Sides: Φ 8.2 Thru.hole: Φ 6.2
40	2-Sides: Φ 10 Thread:M8 x 1.25 Thru.hole: Φ 6.5	2-Sides: Φ 10 Thru.hole: Φ 8.2
50	2-Sides: Φ 11 Thread:M8 x 1.25 Thru.hole: Φ 6.5	2-Sides: Φ 11 Thru.hole: Φ 8.5
63	2-Sides: Φ 11 Thread:M8 x 1.25 Thru.hole: Φ 6.5	2-Sides: Φ 11 Thru.hole: Φ 8.5
80	2-Sides: Φ 14 Thread:M12 x 1.75 Thru.hole: Φ 9.2	2-Sides: Φ 14 Thru.hole: Φ 12.3
100	2-Sides: Φ 17.5 Thread:M14 x 2.0 Thru.hole: Φ 11.3	2-Sides: Φ 17.5 Thru.hole: Φ 14.2

Bore size\Item	P3	P4	S	T1	T2	V	W	X	Y
12	12	4.5	25	16.2	23	6	5	-	-
16	12	4.5	29	19.8	28	6	5	-	-
20	14	4.5	34	24	-	8	6	11.3	10
25	15	5.5	40	28	-	10	8	12	10
32	16	5.5	44	34	-	12	10	18.3	15
40	20	7.5	52	40	-	16	14	21.3	16
50	25	8.5	62	48	-	20	17	30	20
63	25	8.5	75	60	-	20	17	28.7	20
80	25	10.5	94	74	-	25	22	36	26
100	30	13	114	90	-	32	27	35	26

