

Humphrey TAC Air Valves

TECHNICAL SECTION

GENERAL INFORMATION DESCRIPTION AND PRECAUTIONS

Description

- TAC valves: The original and smallest components of the TAC series, with 2-way, 3-way, and 4-way models having #10-32 ports.
- TAC² valves: Larger size and higher flow. An expansion of TAC series. These 3-way and 4-way models have 1/8 pipe ports.
- TAC³ valves: Largest and highest-flow TAC valves. These 4-way models have 1/4 pipe ports.

Port Identification (Varies by model; see individual model drawing)

- | | |
|--------------|------------------------------------------------------|
| IN | Pressure supply port. |
| NO | Pressure supply port, normally open (passing). |
| NC | Pressure supply port, normally closed (not passing). |
| CYL or OUT | Delivery port. |
| C1 or CYL NO | Delivery port, normally open (passing). |
| C2 or CYL NC | Delivery port, normally closed (not passing). |
| EXH | Exhaust port. Vent to atmosphere. |

Note: TAC valve drawings show port markings on valve, but some valves are not furnished with such markings.

Installation

TAC valves can be mounted in any position in most environments within the parameters stated in the specifications. If located near water, oil, or extremely dusty conditions, contaminants may enter via valve exhaust ports causing malfunction or may interfere with movement of button, toggle, or air pilot operator.

Mounting/Assembly of Actuators

Valves can be mounted directly in the supply line, or by using body mounting holes, mounting brackets, or panel mounting nuts. Sometimes actuators can be used to secure actuator and valve to a mounting surface.

MANUAL/MECHANICAL

Manual or mechanical actuators should be adapted to valves/mounting while ensuring adequate stroke of actuator.

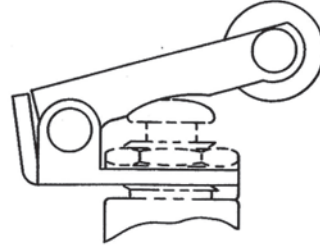

The mounting surface should not prevent complete actuation of valve. Position actuator on valve and secure with locknuts. Actuator should be positioned to provide adequate stroke of valve, without excessive prestroke of valve or overstroke of actuator (specifically models 34B, 34C, 34CW). Secure actuator with locknut/s.

PILOT ACTUATORS

Pilot actuators (34A & 341A) can be adapted to valves/mounting without concern for proper actuator stroke. Pilot actuators (34/341AR, AS, ASR) function best with 3/32" thickness (panel mounting bracket, or locknut and washer) between valve and actuator.

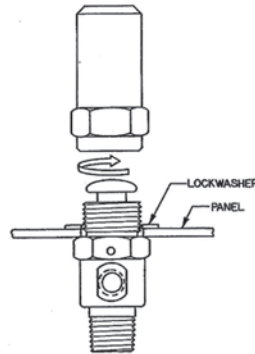

The mounting collar of some actuators is wider than the thickness of certain valves (34C on 31P, or 341AR on 41P, etc.). This requires spacing the valve body away from the mounting surface if body mounting holes are to be used.

Mounting brackets (8-60 & 8-600) have slots that permit mounting adjustment. These brackets can be used to bypass the spacing requirements mentioned above.

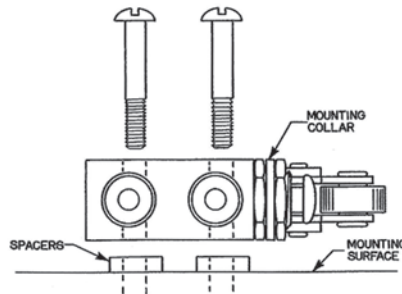

Use as 2-Way Valves

TAC

Model 2P and 2V are specifically designed to be 2-way valves. They have no exhaust port, thus they are either vented to atmosphere; or when used to trap downstream pressure, supply pressure must remain on.

Model 3P and 3V can be used as 2-way valves to vent pressure to atmosphere. These valves, however, will not trap downstream pressure. Attempting to plug the unthreaded exhaust port is not recommended because any trapped pressure will vent around the actuator.

TAC²

Model 31P and 31PPX can be used as 2-way valves to vent pressure to atmosphere or to trap downstream pressure. To trap downstream pressure, plug NO port for 2-way, normally closed; plug NC port for 2-way, normally open.

Model 31V can be used as a 2-way valve to vent pressure to atmosphere. The exhaust port can be plugged to trap downstream pressure, however due to the slight deflection of the stem by the toggle actuator, the valve may not be capable of trapping pressure for extended periods of time.

Use as 3-Way Valves

TAC/TAC²/TAC³

All 4-way models can be used as 3-way valves by plugging the C1 or CYL NO port (3-way, normally closed), or the C2 or CYL NC port (3-way, normally open).

Use As A Selector Valve

TAC

Not possible with TAC series valves.

TAC²

Model 31P, 31V, and 31PPX can be used as a selector valve with supply pressures connected to the NO port (normally open, passing to CYL port) and the NC port (normally closed, not passing to CYL port).

Model 41P, 41PP, and 41PPX can be used as a selector valve with supply pressures connected to the C1 port (normally open, passing to IN port) and the C2 port (normally closed, not passing to IN port). The exhaust ports are to be plugged. (Use Humphrey #PF Plug Fittings). Note that Model 41V cannot be used as a selector valve because of the differential (unbalanced) areas within the valve. Models 41T and 41R cannot be used because exhaust ports cannot be plugged.

TAC³

Model 42P and 42PP can be used as a selector valve with supply pressures connected to the C1 port (normally open, passing to IN) and the C2 port (normally closed, not passing to IN).

Use As A Diverter Valve

TAC

Model 4P, 4PP, 4V, and 4PPX can be used as a diverter valve with supply pressure connected to the IN port. Note that unthreaded exhaust ports vent to atmosphere and cannot be plugged.

TAC²

Model 31P, 31V, and 31PPX can be used as a diverter valve with supply pressure connected to the CYL port. With these models, there is no venting to atmosphere.

Model 41P, 41PP, 41V, and 41PPX can be used as a diverter valve with supply pressure connected to the IN port. Exhaust ports vent to atmosphere, or can be

plugged. Note: plugging the exhaust port nearest the actuator of Model 41V may result in the valve maintaining the actuated position due to the differential (unbalanced) areas within the valve.

TAC³

Model 42P, 42PP, 42A, and 42A2 can be used as a diverter valve with supply pressure connected to the IN port. Exhaust ports vent to atmosphere, or can be plugged.

Media/Pressure

TAC, TAC², and TAC³ valves are designed for use with compressed air or inert gases from 0 to 125 psig (8.5 bar). Media should be clean and uncontaminated. When in doubt, install an air filter with filtering capacity of 40 microns. Periodically remove and clean or replace filter element.

Some valves are also capable of functioning with vacuum. Consult factory and provide desired model number, required vacuum range and description of valve function.

Lubrication

All valves are pre-lubricated at assembly and can be operated without air line lubrication depending on condition of compressed air, volume of air passed through valve, and cycle rate.

TAC valves have smaller sealing surface contact areas, thus are less sensitive to the condition of compressed air than TAC² and TAC³. TAC 2-way and 3-way valves are least sensitive to lubrication due to poppet style design.

Lubricating oils used must be compatible with Buna N and be of sufficient viscosity to assure adequate lubrication. Thin or low viscosity oils (spindle oil, machine oil, etc.) do not provide a good residual film of lubrication. Lubrication compatibility problems can sometimes be satisfied with fluoro-elastomer seals option. Specify w/VAI.

Plumbing

All valves will function with low pressure or restricted volume media supplies.

Air pilot operators may be affected by low pressure, slowly increasing pilot signals, erratic signals, etc. For optimum performance, use 1/8- or 1/4-inch O.D. tubing size and minimum tubing length.

When using a manifold (TAC³) on which more than eight valves will be actuated simultaneously, connect air supply to both ends of manifold. Also exhaust through both ends of manifold. This ensures adequate supply and exhaust capacity. When capturing manifold exhaust, minimize exhaust resistance. Restricted exhaust may cause interference or erratic action of pneumatic devices attached to manifold.

Before connecting fittings and tubing, blow all foreign material from these components. If using a sealant, take extra care that sealant does not enter valve causing malfunction and/or leaks. TAC valve fittings are installed using standard tools. Use of Humphrey Handy Wrench (Model 151-20) is recommended for working with TAC valves, fittings, and accessories. Recommended torque for #10-32 fitting installation is 12-inch pounds (1.3 Newton-meters). *CAUTION: Do not overtighten beyond 24-inch pounds (2.7 Newton-meters).*

Compressed air is powerful and may be dangerous. Before attempting to remove a component from an air line or system, always disconnect the supply air and thoroughly exhaust the line or system. Never attempt to construct, operate, or service anything utilizing compressed air unless you have been properly trained to do so. Failure to heed this warning could result in SERIOUS, EVEN FATAL, PERSONAL INJURY.

Metric Ports

Although these valves are produced using the inch system, all drawings show the metric equivalent in millimeters (indicated by slanted numbers). Port connections may be available in metric. Consult factory.

Specify metric port threads by using letter *E* as a model number prefix. Example: *E3P* has metric ports.

Humphrey does not offer metric size fittings. Contact your local Humphrey distributor for metric size fittings sources.

Flow Rates/C_v

Humphrey recommends "fill/exhaust times", which are related to various chamber sizes, as the best method for calculating total valve and device (specifically, cylinder) response time. Humphrey recognizes the industry's use of flow coefficient *C_v* as a comparison standard.

Consequently, Humphrey offers three types of flow data. The National Fluid Power Association's standards for *C_v*, the scfm flow rate determined by flowing to atmosphere, and Humphrey's preferred "fill/exhaust times".

Model	C _v	SCFM @ 100 PSIG	Fill Time (Seconds) (0 to 90 PSIG) Chamber (cu. in.)			Exhaust Time (Seconds) (100 to 10 PSIG) Chamber (cu. in.)		
			1	10	100	1	10	100
TAC	0.1	6	.049	.490	4.90	.064	.640	6.40
TAC ^{2*}	0.3	18	.018	.180	1.80	.025	.250	2.50
TAC ³	0.4	30	—	.085	0.85	—	.180	1.80

*TAC² Valve Models 41T and 41R have same specifications as TAC valves.

Example of how to calculate fill/exhaust times:

Model 31P One air line (0.125 I.D. x 36-inch long)
100 PSIG supply Air cylinder (1.062-inch bore x 4-inch stroke)

Volume = 0.785 x Diameter squared x stroke or length

Cylinder Volume	=	3.54 cubic inches
Air Line Volume	=	0.43 cubic inches
Total Circuit Volume	=	3.94 or 4 cubic inches

Time to Fill 4 cubic inches
= 40% of .180 sec. for 10 cubic inches = 0.072 sec.

Time to Exhaust 4 cubic inches
= 40% of .250 sec. for 10 cubic inches = 0.100 sec.

Total Cycle Time* = 0.172 sec.

*Although this result is not exact, it is sufficient for most application needs and provides a simple, straight-forward system.

FLOW CONTROL

TAC² 4-way models are furnished (supplied loose) with slotted nylon screws for threading into exhaust ports. This allows metering of exhausting air and provides speed control of device being controlled by valve.

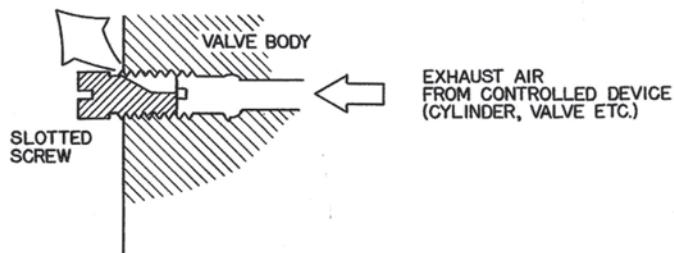
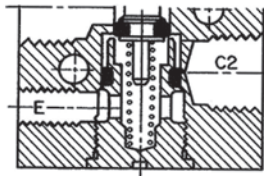

Increased engagement of screw reduces orifice of slot and meters exhausting air.

Model SC1 flow control provides more precise control of exhausting air using a combination of precision needle valve adjustment and Humphrey's unique molded quick exhaust valve shuttle as a check valve.

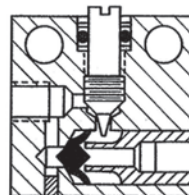

This shuttle provides more consistent control than ball shuttles which are typically used in other miniature flow control designs. Ball shuttles require spring loading. When spring loaded, ball shuttles restrict exhaust flow in flow control valve and may even cause reverse metering. Non-spring loaded ball shuttles are erratic when engaging valve seat in controlled flow. The unique Humphrey molded quick exhaust shuttle does not incur any of these disadvantages.

Model C1 check valve, Model SQE shuttle and Quick Exhaust Valve also employ Humphrey's unique molded quick exhaust shuttle. The merits of this component are discussed immediately above.

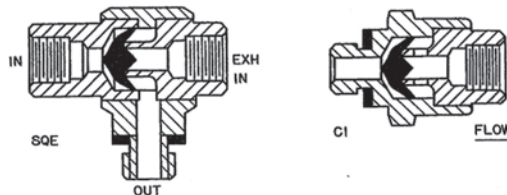

PACKAGING/INDIVIDUAL AND BULK QUANTITIES

Individual components are packaged for cleanliness in clear plastic bags. Permits easy identification of model number.

Customers purchasing large quantities may prefer to reduce unpacking cost by ordering in bulk quantities. Bulk packs contain multiple units. Consult factory.

TYPICAL CIRCUITS

Drawings are presented as examples of methods in which components might typically be used, and are shown for descriptive purposes only. Proper, safe functioning of any system which employs the components as graphically described, or in any other manner, must be ensured by the designer.

"Time Delay" or "Sequence"

Circuit provides delay between functions.

Maintained actuation of 3-way valve supplies pilot pressure through SC1 valve and volume chamber at controlled rate, resulting in slowly building (Time Delay) of pilot pressure upon actuator (34AS). When actuation pressure of actuator is achieved, actuator shifts 4-way valve and extends cylinder. Cylinder remains extended until 3-way valve is released and pilot system is exhausted. Note: Rate of cycling of this circuit may be limited to the time required to exhaust pilot system.

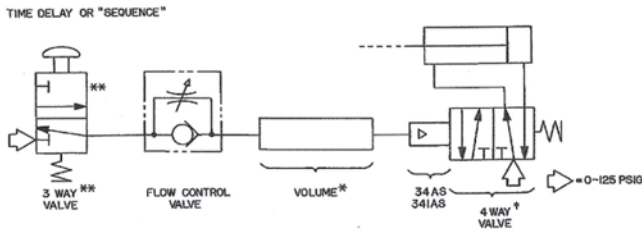

* One cubic inch of volume equals approximately two seconds delay.

† Valve used with 34AS or 34IAS actuator must be TAC Series but can be either 2-, 3- or 4-way depending on work function (Double Acting Cylinder shown).

**Valve used can be any 3-way or from one side of any 4-way.

"One Shot"

Circuit provides momentary output signal from maintained input signal of 3-way valve.

Maintained actuation of manual 3-way valve** supplies pilot pressure to actuator (34AR) which actuates 3-way valve† and extends cylinder. Actuator automatically resets and permits valve to de-actuate, even though pressure to actuator is maintained. 3-way valve** must be released and pilot system exhausted before another output can be generated.

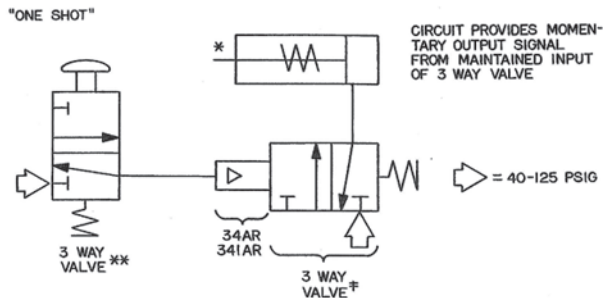

* Single acting cylinder shown.

**Valve used can be any 3-way or from one side of any 4-way.

† Valve used with 34AR or 34IAR operator must be TAC Series, but can be 2-, 3-, or 4-way depending on work function.

"Ballpoint Pen"

Circuit provides a maintained output signal every other time the 3-way valve is actuated.

Momentary actuation of 3-way valve supplies pressure to both shuttle valves (SQE). Right-hand shuttle and operator (34AR) will be pressurized and reset due to pressure from 4-way valve. Left-hand shuttle and operator shift 4-way valve to opposite position and extend cylinder. Cylinder remains extended until 3-way valve is released and re-actuated causing circuit to return to position shown.

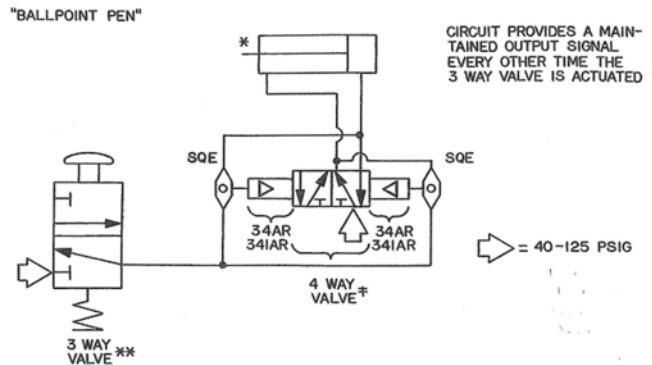

* Double acting cylinder shown. Single acting cylinder can be used.

† Valve used with 34AR or 34IAR operator must be TAC Series 4-way model: 4PP, 41PP, or 42PP.

**Valve used can be any 3-way or from one side of any 4-way.

TROUBLESHOOTING

Circuit malfunction problems are normally caused by circuit design errors, insufficient or slow building of pressure, improper lubrication, or contaminated air supplies.

It should be determined conclusively that it is in fact the valve that is causing a malfunction. Often it is other components or factors.

1. Insure presence of pressure; blocked or defective fittings are frequent causes of circuit start-up problems.
2. Insure adequate duration of pilot signal to air pilot operators.
3. Insure proper stroke of manual, mechanical, or air pilot operators. See specific model description.
4. Insure that contamination does not cause improper valve/actuator stroke. **Note:** Model 34/341AR and 34/341ASR can accumulate water under the actuator piston if air system is contaminated with water.

WARRANTY

All valves have a one-year warranty from date of manufacture. This warranty includes repair and/or replacement at no charge should the product be deemed defective due to workmanship and/or material.

HOW THEY WORK

Model 2P (Basic TAC 2-way, spring return)

2-way, 2-position, spring return. Supply pressure enters IN port and holds ball in seat. Ball is spring biased to insure sealing at low pressure. Actuation causes valve stem to push ball out of seat. This allows flow from IN to CYL port. Being a 2-way, this valve has no exhaust port, thus there is no way for media to exhaust. De-actuation causes the ball to move back into the seat, establishing the original condition.

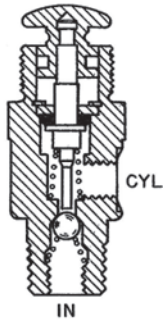

Normally open, with air supply connected to NO port: Supply pressure does not hold stem in position due to equal/balanced areas. Spring bias ensures closing. Actuation moves valve stem and causes exhaust via the NC port which serves as the exhaust port. De-actuation permits spring to re-establish normally open position.

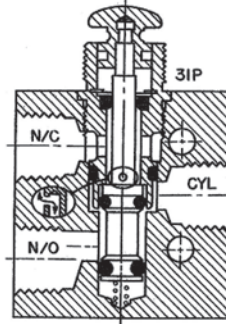

Model 3P (Basic TAC 3-way, spring return)

3-way, 2-position, spring return. Supply pressure enters IN port and holds ball in seat. Ball is spring biased to insure sealing at low pressure. Actuation causes valve stem to close EXH with o-ring seal and to push ball out of seat. This allows flow from IN to CYL port. De-actuation causes the ball to move back into the seat, establishing the original condition. At the same time, pressure is exhausted via the twin exhaust ports.

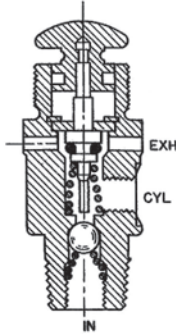

Model 4P (Basic TAC 4-way, spring return)

4-way (NC/NO), 5-port, 2-position, spring return. Supply pressure flows from IN to NO port; NC port is exhausted. Actuation moves balanced stem allowing flow from IN to NC port; NO port is exhausted. De-actuation permits spring to re-establish original condition.

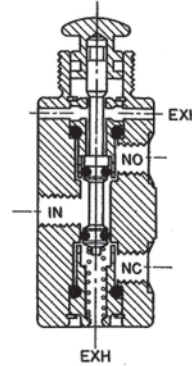

Model 4P/PPX (Basic TAC 4-way, detented)

4-way (NC/NO), 5-port, 2-position, detented. Supply pressure flows from IN to NO port; NC port is exhausted. Actuation moves balanced stem allowing flow from IN to NC port; NO port is exhausted. Actuation of valve's opposite actuator re-establishes original condition.

Model 31P (Basic TAC² 3-way, spring return)

3-way, 2-position, spring return, universal valve. Can be used normally closed, normally open, or as a selector or diverter.

Normally closed, with supply connections to NC port: Supply pressure holds stem in position via "air spring" created by stem orifice which channels supply pressure to bottom of stem. Spring bias ensures closing at low pressure. Actuation moves valve stem allowing flow from NC port. De-actuation permits exhaust via the NO port which serves as the exhaust port.

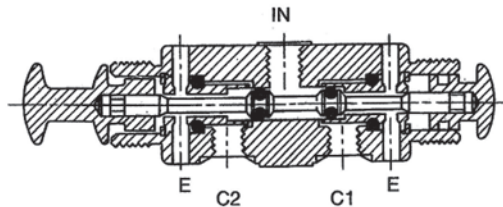

Model 41P (Basic TAC² 4-way, spring return)

4-way, (NC/NO), 5-port, 2-position, spring return.

Supply pressure flows from IN to C1 port; C2 port is exhausted via the "bottom" exhaust port (lower of two exhaust ports in drawing). Actuation moves balanced valve stem allowing flow from IN to C2 port; C1 port is exhausted via "top" exhaust port. De-actuation permits spring to re-establish original condition.

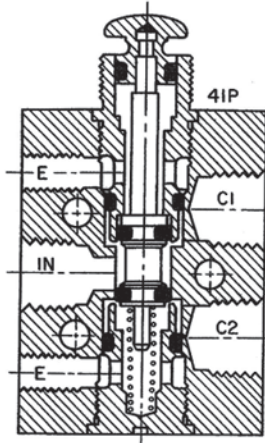

Model 42P (Basic TAC³ 4-way, spring return)

4-way (NC/NO), 5-port, spring return.

Supply pressure flows from IN to C1; C2 is exhausted via exhaust port nearest actuator. Supply pressure holds stem in position via "air spring" created by stem orifice (under patented floating center o-ring) which channels supply pressure to bottom of stem. Spring bias ensures closing at low pressure. Actuation moves valve stem allowing flow from IN to C2 port while C1 port is exhausted via other exhaust port. De-actuating valve permits spring and air spring to re-establish the original condition.

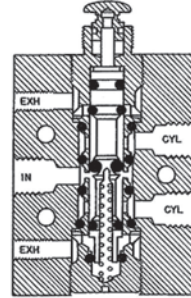

Model 41PP (Basic TAC² 4-way, detented)

4-way (NC/NO), 5-port, 2-position, detented.

Supply pressure flows from IN to NO port; NC port is exhausted. Actuation moves balanced stem allowing flow from IN to NC port; NO port is exhausted. Actuation of valve's opposite actuator re-establishes original condition.

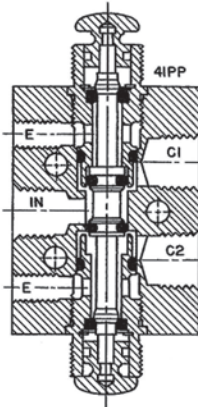

Model 42PP (Basic TAC³ 4-way, detented)

4-way (NC/NO), 5-port, detented.

Supply pressure flows from IN to C1; C2 is exhausted via exhaust port opposite valve actuator last actuated. Stem is balanced without "air spring." Actuation moves valve stem allowing flow from IN to C2 port while C1 port is exhausted via other exhaust port. Actuation of valve's opposite actuator re-establishes the original condition.

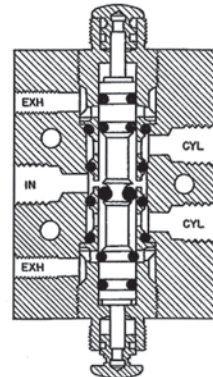

TAC AIR PILOT OPERATORS

Air pilot operators thread directly onto the collars of push-button valves and the Model ESB Electric Switch Bracket.

Models 34A, 341A

Air pressure applied to pilot port drives a V-cup sealed piston to actuate a valve's push-button. The 341A air pilot operator provides approximately twice the actuation force of the 34A at same pilot pressure. Use for lower pilot pressure requirements or to amplify weak pilot signals, especially to 41PP and 42PP valves with positive detents.

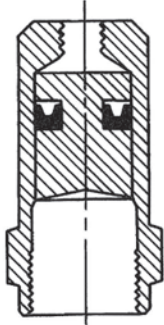

34A

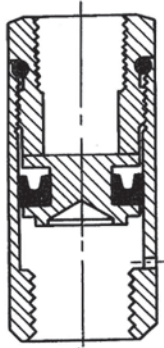

341A

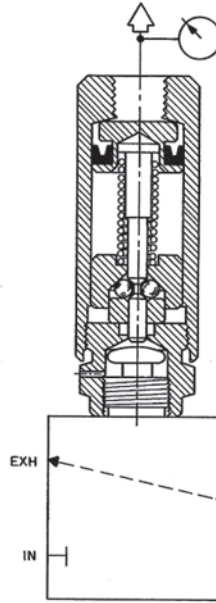

341AS

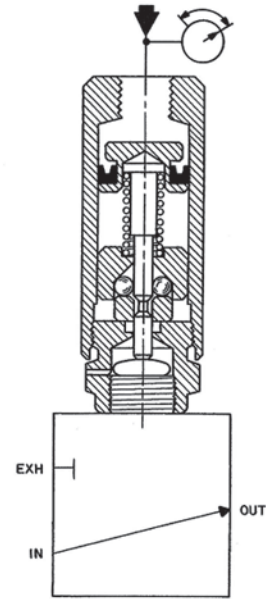

Models 34AS, 341AS

Air pressure applied to pilot port builds upon V-cup sealed piston until pressure against piston area generates sufficient force to overcome ball detents. Used primarily for time-delay or sequence circuits and other slow building pilot pressure applications. Actuation is delayed until pilot pressure reaches 35 PSIG \pm 5 PSIG. At this pressure, the operator piston snaps forward to actuate valve and remains shifted until pilot pressure is exhausted.

Models 34AR, 341AR

Used primarily for conversion of maintained signal to a momentary actuation. Often referred to as "one-shot." Air pressure applied to pilot port generates force upon V-cup sealed piston which overcomes spring force and extends piston rod to actuate push-button valve. Small orifice in piston and two-piece piston and piston rod permits pressure to equalize and balance piston force.

Spring then creates unbalance and returns piston and piston rod to original position resulting in only a momentary actuation of valve, even though air pressure remains applied to pilot port. This reset occurs within 0.3 seconds at 40 PSIG within 0.5 seconds at 100 PSIG and within 0.7 seconds when used with 4PP, 41PP, or 42PP valves. Maximum cycle life is obtained at 40-65 PSIG maximum.

Any erratic action of the operators is often caused by small diameter or long pilot lines, restricted fittings, low flow pilot valves, slow building, or exhausting pilot signals, or excessive moisture or space between operator and valve body and can be eliminated by correcting these conditions.

Models 34ASR, 341ASR

Used to simplify pneumatic circuitry requiring "snap" and "reset" action by providing both functions in a single unit. Air pressure applied to pilot port builds upon V-cup sealed piston until pressure against piston area generates sufficient force to overcome ball detents. Actuation is delayed until pilot pressure reaches 35 PSIG \pm 5 PSIG, and then the operator piston snaps forward to actuate push-button valve. At this point, small groove in cylinder wall permits pressure to equalize and balance piston force.

Spring then creates unbalance and returns piston and piston rod to original position resulting in only a momentary actuation of valve, even though air pressure remains applied to pilot port. After snap action, the piston resets within approximately 0.3 seconds at 40 PSIG, within 0.5 seconds at 100 PSIG, and within 0.7 seconds when used with 4PP, 41PP, or 42PP valves.

NOTE: The recommended maximum pilot pressure is 60 PSIG. If this pressure is exceeded, the operator will recycle snapping and resetting a second time.

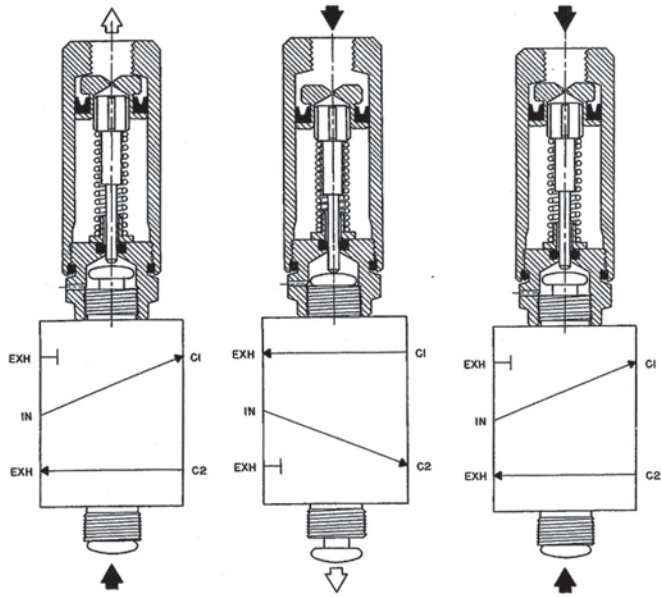

341AR

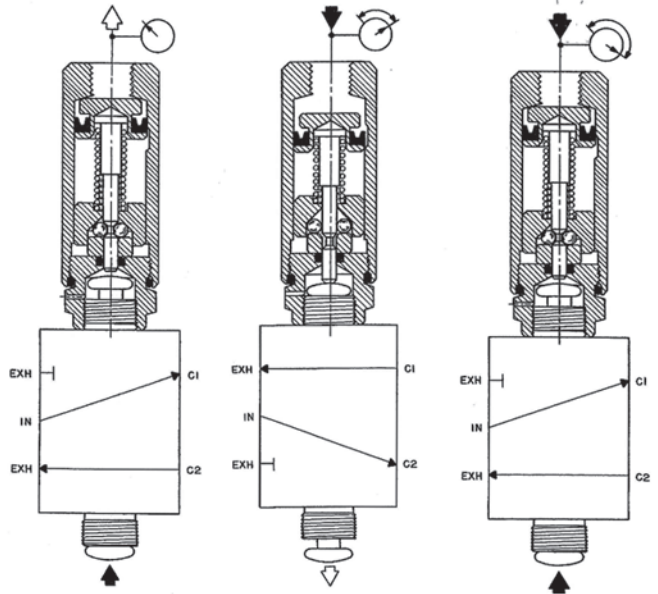

341ASR